

**STUDY MATERIAL ON**  
**STRENGTH OF MATERIALS**  
**(SOM)**

**(TH-2) 3RD SEMESTER**



Prepared by

**GITANJALI SETHI, Sr. LECTURER**

**DEPARTMENT OF MECHANICAL ENGINEERING**  
**GOVT. POLYTECHNIC JAJPUR**

## CHAPTER 1.0

# SIMPLE STRESS AND STRAIN

### 1.1 - Types of Load

Load is an external force. Hydraulic force, steam pressure, tensile force, compressive force, shear force, spring force and different types of load. Again load may be classified as live load, dead load.

#### Definition

Strength of material is the study of the behaviour of structural and machine members under the action of external loads, taking into account the internal forces created and resulting deformation.

#### Types of load

The simplest type of load (P) is a direct pull or push, known technically as tension or compression.

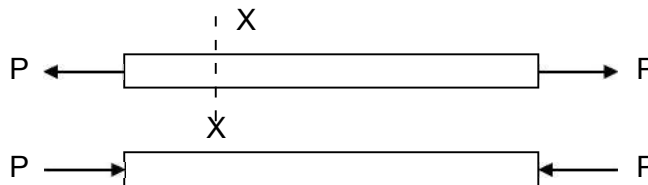

If a member is in motion the load may be caused partly by dynamic or inertia forces. For instance, the connecting Rod of a reciprocating engine, load on a fly wheel.

## STRESS

#### Definition

The Force transmitted across any section, divided by the area of that section, is called intensity of stress or stress.

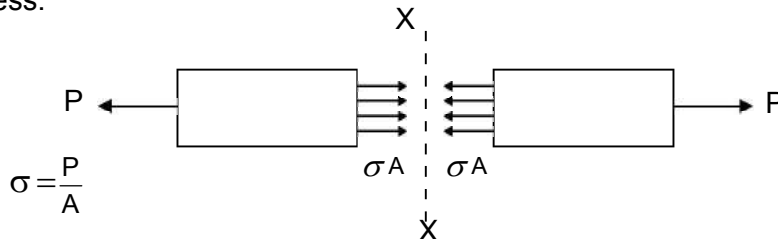

Where

$$\sigma = \frac{P}{A}$$

$\sigma$  - Stress

P - Load

A - Area

$\sigma A$  - Internal forces of cohesion

#### Direct stress (Tensile / compressive)

Stresses which are normal to the plane on which they act are called direct stresses and either tensile or compressive.

Unit - N / m<sup>2</sup>

## STRAIN

Strain is a measure of the measure of the deformation produced in the member by the load.

If a rod of length L is in tension and the elongation produced is X, then the direct

$$\text{strain} = \frac{\text{Elongation}}{\text{Original length}} \quad \epsilon = \frac{X}{L}$$

Tensile strain will be positive compressive strain will be negative.

## Hooke's Law

This states that strain is proportional to the stress producing it.

A material is said to be elastic if all the deformations are proportional to the load.

## Principle of superposition

It states that the resultant strain will be the sum of the individual strains caused by each load acting separately.

## Young's Modules

Within the limits for which Hooke's law is obeyed, the ratio of the direct stress to the strain produced is called young's modules or the modules of Elasticity, i.e.  $E = \frac{\sigma}{\epsilon}$

For a bar of uniform cross-section A and length L this can be written as  $E = \frac{PL}{AX}$  or  $\frac{PL}{AE} = X$

## Tangential Stress

If the applied load consists of two equal and opposite parallel forces not in the same line, then there is a tendency for one part of the body to slide over or shear from the other part across any section LM.

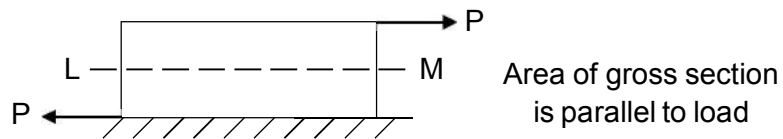

$$\tau = \frac{P}{A}$$

Shear stress is tangential to the area over which it acts.

Every shear stress is accompanied by an equal complementary shear stress.

## Shear Strain

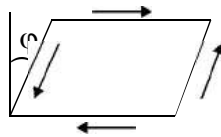

The shear strain or slide is  $\phi$ , and can be defined as the change in the right angle. It is measured in radians.

## Modules of rigidity

For elastic material shear strain is proportional to the shear stress.

Ratio  $\frac{\text{Shear Stress}}{\text{Shear Strain}} = \text{Modules of rigidity}$

Ratio  $G = \frac{\tau}{\phi} \text{ N/mm}^2$

## 1.2 Stresses in composite section

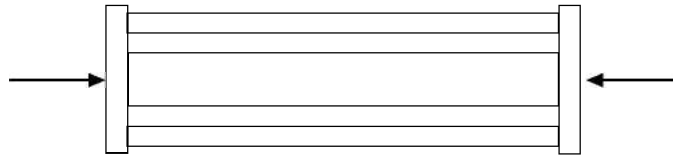

Any tensile or compressive member which consists of two or more bars or tubes in parallel, usually of different materials is called compound bars.

### Analysis

A compound bar is made up of a rod of area  $A_1$  and modulus  $E_1$  and a tube of equal length of area  $A_2$  and modulus  $E_2$ . If a compressive load  $P$  is applied to the compound bar find how the load is shared. Since the rod and tube are of the same initial length and must remain together then the strain in each part must be the same. The total load carried is  $P$  and let it be shared  $W_1$  and  $W_2$ ,

$$\varepsilon_1 = \varepsilon_2, L_1 = L_2$$

$$\text{compatibility equation: } \frac{W_1}{A_1 E_1} = \frac{W_2}{A_2 E_2}$$

$$\text{Equilibrium equation: } W_1 + W_2 = P$$

$$\text{Substituting, } W_2 = \frac{A_2 E_2}{A_1 E_1} \times W_1$$

$$\text{from (i) \& (ii) given } W_1 \left( 1 + \frac{A_2 E_2}{A_1 E_1} \right) = P \text{ or}$$

$$W_1 = \frac{P A_1 E_1}{A_1 E_1 + A_2 E_2}$$

$$\text{Then } W_2 = \frac{P A_2 E_2}{A_1 E_1 + A_2 E_2}$$

### Example

A composite bar is made up of a brass rod of 25mm diameter enclosed in a steel tube, being co-axial of 40mm external diameters and 30mm internal diameter as shown below. They are securely fixed at each end. If the stress in brass and steel are not to exceed 70MPa and 120 MPa respectively find the load ( $P$ ) the composite bar can safely carry.

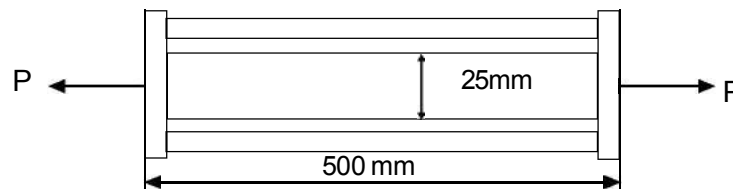

Also find the change in length, if the composite bar is 500mm long. Take  $E$  for steel Tube as 200 GPa and brass rod as 80 GPa respectively.

### Data Given

Let steel tube denoted as 1 and brass rod denoted as 2

$$d_{1o} = 40\text{mm} \quad E_1 = 200\text{GPa}$$

$$d_{1i} = 30\text{mm} \quad E_2 = 80\text{GPa}$$

$$d_2 = 25\text{mm}$$

$$\sigma_1 = 120\text{MPa} \quad W_1 - \text{Load carried by tube}$$

$$\sigma_2 = 70\text{MPa} \quad W_2 - \text{Load carried by rod.}$$

From compatibility equation :

$$\frac{W_1}{A_1 E_1} = \frac{W_2}{A_2 E_2}$$

$$A_1 = \frac{\pi}{4} (d_{1o}^2 - d_{1i}^2) = \frac{\pi}{4} (40^2 - 30^2)$$

$$\Rightarrow A_1 = 500 \text{ mm}^2$$

$$\text{and } A_2 = \frac{\pi}{4} 25^2 = 491 \text{ mm}^2$$

Now putting in equation – (1)

$$\Rightarrow W_1 = W_2 \times \frac{550 \times 200}{491 \times 80}$$

$$\Rightarrow W_1 = 2.8 W_2$$

$$W_1 = \sigma_1 A_1 = 120 \times 550 = 66000 \text{ N}$$

$$\text{and } W_2 = \frac{W_1}{2.8} = \frac{66000}{2.8} = 2357 \text{ N}$$

From equilibrium equation

$$\Rightarrow P = W_1 + W_2$$

$$= 66000 + 2357 = 89.57 \text{ KW (Ans)}$$

Change in length

$$\delta l_1 = \delta l_2 = \frac{W_1 l_1}{A_1 E_1} = \frac{66000 \times 500}{550 \times 200 \times 10^3} = 0.3 \text{ mm}$$

### Poisson's Ratio

The ratio between lateral strain to the linear strain is a constant which is known as Poisson's ratio.

The symbol is ' $\mu$ '.

### Bulk Modulus

When a body is subjected to three mutually perpendicular stresses of equal intensity the ratio of direct stress to the corresponding volumetric strain is known as bulk modulus.

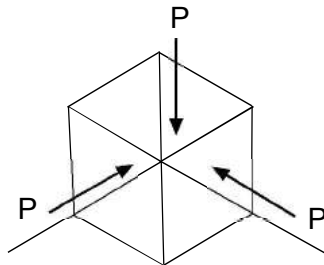

$$\text{Fig. } K = \frac{-P}{\delta V / V}$$

P - hydrostatic pressure

(-) - negative sign taking account of the reduction in volume.

### Relation between K and E

The above figure represents a unit cube of material under the action of a uniform pressure P. It is clear that the principle stresses are -P, -P and -P and the linear strain in each direction is

$$-P/E + \mu P/E + \mu P/E = \frac{-P}{A} (1-2\mu)$$

But we know

Volumetric strain = sum of linear strain

$$\text{By definition } K = \frac{-P}{\delta V / V}$$

$$\text{or } K = \frac{-P}{\frac{-3P}{E}(1-2\mu)}$$

$$\text{or } K = \frac{E}{3(1-2\mu)}$$

$$\text{or } E = 3K(1-2\mu)$$

### Relation between E and G

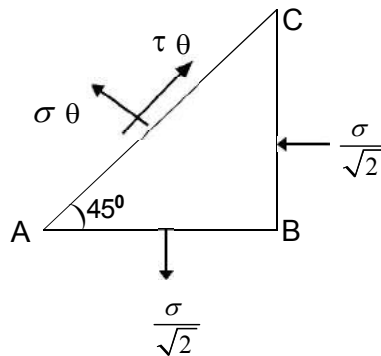

It is necessary first of all to establish the relation between a pure shear and pure normal stress system at a point in an elastic material.

In the above figure the applied stresses are  $\sigma$  tensile on AB and  $\sigma$  compressive on BC. If the stress components on a plane AC at  $45^\circ$  to AB are  $\sigma_\theta$  and  $\tau_\theta$  Then the forces acting are as shown taking the area on AC as units.

Resolving along and at right angle to AC

$$\tau_\theta = \frac{\sigma}{\sqrt{2}} \sin 45 + \frac{\sigma}{\sqrt{2}} \cos 45 = \sigma$$

$$\text{and } \sigma_\theta = \frac{\sigma}{\sqrt{2}} \cos 45 - \frac{\sigma}{\sqrt{2}} \sin 45 = 0$$

So a pure shear on planes at  $45^\circ$  to AB and BC.

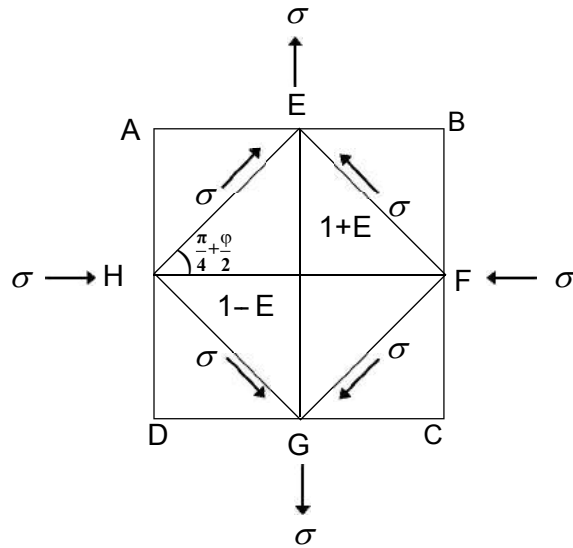

This figure shows a square element ABCD, sides of unstrained length 2 units under the action of equal normal stresses,  $\sigma$  tension & compression. then it has been shown that the element EFGH is in pure shear of equal magnitude  $\sigma$ .

$$\text{Liner strain in direction EG} = \frac{\sigma}{E} + \frac{\mu\sigma}{E}$$

$$\text{Say } \varepsilon = \frac{\mu}{E}(1 + \mu)$$

$$\text{Liner strain in direction HF} = -\frac{\sigma}{E} - \frac{\mu\sigma}{E} = -\varepsilon$$

Hence the strained lengths of EO and HO are  $l + \varepsilon$  and  $l - \varepsilon$  respectively.

$$\text{The shear strain } \varphi = \frac{\sigma}{G}$$

on one element EFGH and the angle EHG will increase by to  $\frac{\pi}{4} + \varphi$  and angle EHO =  $\frac{\pi}{4} + \frac{\varphi}{2}$

$$\text{Considering the triangle } \tan \text{EHO} = \frac{EO}{HO}$$

$$\tan\left(\frac{\pi}{4} + \frac{\varphi}{2}\right) = \frac{1 + \varepsilon}{1 - \varepsilon}$$

$$\frac{1 + \varepsilon}{1 - \varepsilon} = \tan \frac{\tan \frac{\pi}{4} + \tan \frac{\varphi}{2}}{1 - \tan \frac{\pi}{4} \cdot \tan \frac{\varphi}{2}}$$

$$= \frac{1 + \frac{\varphi}{2}}{1 - \frac{\varphi}{2}}$$

$$\varepsilon = \frac{\varphi}{2}$$

$$(1 + \mu) \frac{\sigma}{\varepsilon} = \frac{\sigma}{2G}$$

then rearranging  $E = 2G(1 + \mu)$

$$\text{by removing } \mu, E = \frac{9GK}{G + 3K}$$

### 1.3 Temperature stress

Determination of temperature stress in composite bar (single core).

#### Temperature stresses in Composite Bar

If a compound bar made up of several materials is subjected to a change in temperature there will be tendency for the components parts to expand different amounts due to the unequal coefficient of thermal expansion. If the parts are constrained to remain together then the actual change in length must be the same for each. This change is the resultant of the effects due to temperature and stresses condition.

Now let  $\sigma_1$  = Stress in brass

$\varepsilon_1$  = Strain in brass

$\alpha_1$  = Coefficient of linear expansion for brass

$A_1$  = Cross sectional area of brass bar

and  $\sigma_2, \varepsilon_2, \alpha_2, A_2$  = Corresponding values for steel.

$\varepsilon$  = Actual strain of the composite bar per unit length.

As compressive load on the brass is equal to the tensile load on the steel, therefore

$$\sigma_1 \cdot A_1 = \sigma_2 \cdot A_2$$

strain in brass  $\varepsilon_1 = \alpha_1 \Delta t - \varepsilon$

$$\varepsilon_2 = \varepsilon - \alpha_2 \Delta t_2$$

$$\varepsilon_1 + \varepsilon_2 = \alpha_1 \Delta t_1 + \alpha_2 \Delta t_2 = \Delta t (\alpha_1 - \alpha_2)$$

#### Thermal stresses in simple bar

Let L = original length of the body

$\Delta t$  = Increase in temperature

$\alpha$  = Coefficient of linear expansion.

We know that the increase in length due to increase of temperature

$$\delta L = L \alpha \Delta t$$

$$\varepsilon = \frac{\delta L}{L} = \frac{L \alpha \Delta t}{L} = \alpha \Delta t$$

$$\text{Stress } \sigma = \varepsilon E$$

#### Example -1

An aluminium alloy bar fixed at its both ends is heated through 20K find the stress developed in the bar. Take modulus of elasticity and coefficient of linear expansion for the bar material as 80 GPa and  $24 \times 10^{-6}/K$  respectively.

#### Data Given

$$\Delta t = 20K$$

$$E = 80GPa = 80 \times 10^3 N/mm^2$$

$$\alpha = 24 \times 10^{-6}/K$$



### Solution

Then the thermal stress

$$\begin{aligned}\sigma_t &= \alpha \Delta t E = 24 \times 10^{-6} \times 20 \times 80 \times 10^3 \\ &= 38.4 \text{ N/mm}^2 = 38.4 \text{ MPa}\end{aligned}$$

### Example - 2

A flat steel bar 200mm X 20mm X 8mm is placed between two aluminium bars 200mm X 20mm X 6mm. So as to form a composite bar. All the three bars are fastened together at room temperature. Find the stresses in each bar where the temperature of the whole assembly is raised through 50°C, Assume  $E_s = 200\text{GPa}$ ,  $E_a = 80\text{GPa}$ ,  $\alpha_s = 12 \times 10^{-6}/^\circ\text{C}$ ,  $\alpha_a = 24 \times 10^{-6}/^\circ\text{C}$

### Data given

Aluminium	6mm
Steel	8mm
Aluminium	6mm

$$\Delta t = 50^\circ\text{C}, E_s = 200\text{GPa} = 200 \times 10^3 \text{ N/mm}^2$$

$$E_a = 80\text{GPa} = 80 \times 10^3 \text{ N/mm}^2$$

$$\alpha_s = 12 \times 10^{-6}/^\circ\text{C}, \alpha_a = 24 \times 10^{-6}/^\circ\text{C}$$

### Solution

$$A_s = 20 \times 8 = 160 \text{ mm}^2$$

$$A_a = 2 \times 20 \times 6 = 240 \text{ mm}^2$$

$$\alpha_s = \frac{A_a}{A_s} \times \sigma_a = \frac{240}{160} \times \sigma_a = 1.5 \sigma_a$$

$$\epsilon_s = \frac{\sigma_s}{E_s} = \frac{\sigma_s}{200 \times 10^3}$$

$$\epsilon_a = \frac{\sigma_a}{E_a} = \frac{\sigma_a}{80 \times 10^3}$$

$$\epsilon_s + \epsilon_a = t(\alpha_a - \alpha_s)$$

$$\frac{\sigma_s}{200 \times 10^3} + \frac{\sigma_a}{80 \times 10^3}$$

$$= 50(24 \times 10^{-6} - 12 \times 10^{-6})$$

$$\text{or, } \frac{1.5 \sigma_a}{200 \times 10^3} + \frac{\sigma_a}{80 \times 10^3}$$

$$= 50 \times 12 \times 10^{-6}$$

$$\Rightarrow \sigma_a = 30 \text{ N/mm}^2 = 30 \text{ MPa}$$

$$\sigma_s = 1.5 \sigma_a = 1.5 \times 30 = 45 \text{ N/mm}^2 = 45 \text{ MPa}$$

**1.4. Strain energy resilience stress due to gradually applied load and compact load.**

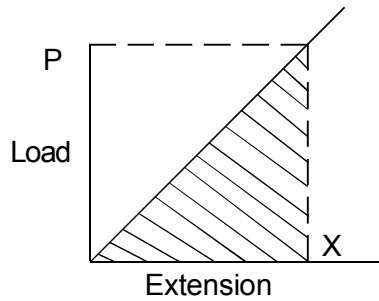

**Strain Energy**

The strain energy (U) of the bar is defined as the work done by the load in strain it.

For a gradually applied load or static load the work done is represented by the shaded area in above figure.

$$U = \frac{1}{2} P \cdot X$$

$$U = \frac{1}{2} \sigma A \frac{\sigma}{E} L$$

$$= \frac{1}{2E} \sigma^2 A L = \frac{1\sigma}{2E} \text{Vol.}$$

**Resilience**

The strain energy per unit volume usually called as resilience in simple tension or compression

is  $\frac{\sigma^2}{2E}$ .

**Proof resilience**

It is the value at the elastic limit or at the proof stress for non-ferrous materials.

Strain energy is always a positive quantity and being work units will be expressed as Nm (i.e. joules)

**Example 1**

Calculate the strain energy of the bolt as shown below under a tensile load of 10 KN. Show that the strain energy is increased for the same max stress by turning down the same of the bolt to the root diameter of the turned,  $E=20500 \text{ N/mm}^2$

**Data Given**

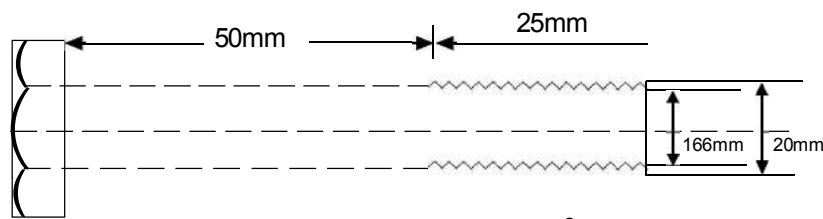

$P= 10 \text{ KN}, E= 205,000 \text{ N/mm}^2$

**Solution**

It is a normal practice to assume that the load is distributed events over the core.

$$A_c = \frac{\pi}{4} 16.6^2 = 217 \text{ mm}^2$$

$$\text{Stress in screwed portion} = \frac{P}{A_c} = \frac{10,000}{217} = 46 \text{ N/mm}^2$$

$$\text{Stress in shank} = \frac{P}{A_c} = \frac{10,000}{\frac{\pi}{4} \times 20^2} = 31.8 \text{ N/mm}^2$$

$$\text{Total strain Energy} = \frac{1}{2 \times 205000} (46^2 \times 210 \times 25 + 31.8^2 \times 314 \times 50) = 67 \text{ N/mm}^2$$

If turned to 16.6mm

$$\text{S.E} = \frac{1}{2 \times 205000} (46^2 \times 217 \times 75) = 84 \text{ N/mm}$$

### Impact load

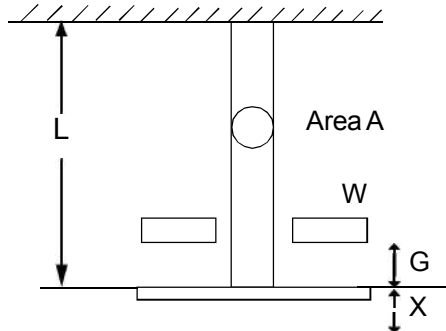

Supposing a weight \$W\$ falls through a height 'h' on to 'a' collar attached to one end of a uniform bar, the other end being fixed. Then an extension will be caused which is greater than that due to one application of the same load gradually applied.

Let \$X\$ is the maximum extension, set up and the corresponding strain is \$\sigma\$ .

Let \$P\$ be the equivalent static load which would produced the same extension \$X\$.

$$\text{Then the strain energy at this instant} = E1 = \frac{1}{E} (\sigma_1 - \mu \sigma_2)$$

$$\text{or } E1 = \frac{Pd}{4t_1 E} (2 - \mu)$$

Neglecting loss of energy at compact loss of PE of weight = Gain of strain energy.

$$w(h+x) = \frac{1}{2} Px$$

$$\text{or } w(h + \frac{PL}{AE}) = \frac{1}{2} P^2 L / AE$$

Rearranging and multiplying through \$AE/L\$

$$P^2 / 2 - WP - WhAE/L = 0$$

Solving and discarding the negative root

$$P = W + \sqrt{W^2 + 2WGAE/L}$$

$$= W [1 + \sqrt{1 + 2hAE/WL}]$$

$$\text{From which } X = \frac{PL}{AE}, \sigma = \frac{P}{A} \text{ can be found}$$

$$\text{When } h=0, P=2W$$

i.e. the stress produced by a suddenly applied load is twice the static stress. Ex- Referring figure-1, let a mass of 100Kg falls 4cm on to a collar attached to a bar of 2 cm dia, 3mm long find max stress, \$E = 205,000 \text{ N/mm}^2\$

$$\sigma = \frac{P}{A} = \frac{W}{A} [1 + \sqrt{1 + 2hAE/WL}]$$

$$= \frac{981}{100\pi} [1 + \sqrt{1 + \frac{2 \times 40 \times \pi \times 100 \times 205000}{981 \times 3 \times 1000}}]$$

$$= 134 \text{ N/mm}^2$$

## THIN CYLINDER AND SPHERICAL SHELL UNDER INTERNAL PRESSURE

### 2.1. Definition of hoop stress

By symmetry the three principal stresses in the shell will be the

- (i) circumferential or hoop stress
- (ii) longitudinal stress
- (iii) radial stress.

### Thin cylinder :

If the ratio of thickness to internal diameter is less than about 1/20, then the hoop stress and longitudinal stress are constant over the thickness and the radial stress is small and can be neglected.

### 2.2 Hoop stress or circumferential stress derivation

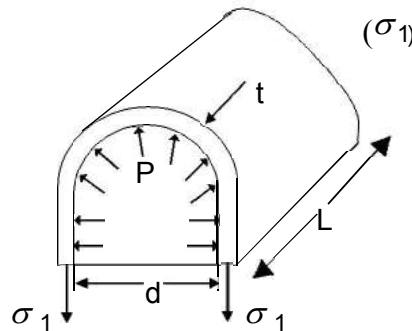

Let d - internal diameter  
l - length of cylinder  
t - thickness  
p - pressure

consider the equilibrium of a half cylinder of length L.

section through a diametral plane,  $\sigma_1$  acts on an area  $2tL$  and the resultant vertical pressure force is found from the projected area horizontal  $d \times L$

### **Equating forces**

$$\sigma_1 \times 2 \times tL = P \times d \times L$$

$$= \sigma_1 = \frac{PD}{2t}$$

hoop stress in a tensile stress acts circumferentially on the cylinder.

### Longitudinal stress $\sigma_2$ Derivation

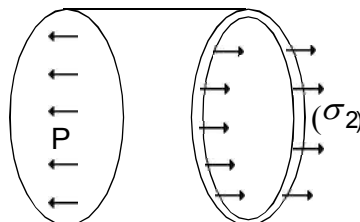

Consider the equilibrium of a section cut by a transverse plane,  $\sigma_2$  acts on an area  $\pi_2$ , dt (d should be the main diameter) and pacts on a projected area of  $\frac{\pi}{4}d^2$  equating the forces.

Equating the forces

$$\sigma_2 \times dt = P \times \frac{\pi}{4} d^2$$

Whatever the actual shape of the end

$$\text{i.e. } \sigma_2 = \frac{Pd}{4t}$$

In case of long cylinder or tubes this stress may be neglected.

### Thin spherical shell under internal pressure derivation

Again the radial stress will be neglected and the circumferential or hoop stress will be neglected and by symmetry the two principal stresses are equal, in fact the stress in any tangential direction is equal to  $\sigma$ .

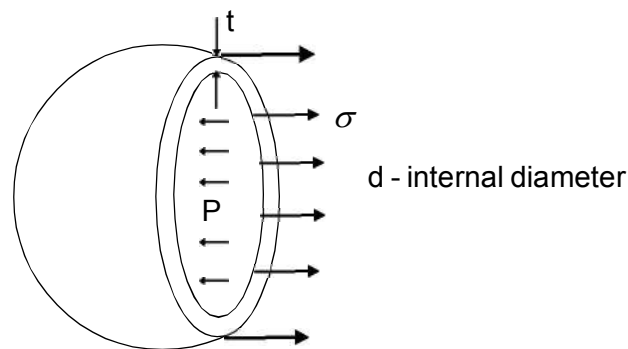

From above figure it is seen that

$$\sigma \pi dt = P \frac{\pi}{4} d^2$$

$$\text{i.e. } \sigma = \frac{Pd}{4t}$$

### Volumetric strain

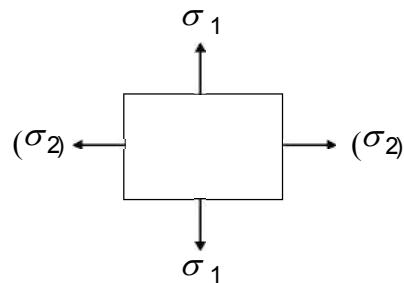

### Hoop Strain

$$\epsilon_1 = \frac{1}{E} (\sigma_1 - \mu \sigma_2)$$

$$\text{or } \epsilon_1 = \frac{Pd}{4t_1 E} (2 - \mu)$$

### Longitudinal Strain

$$\epsilon_2 = \frac{1}{E} (\sigma_2 - \mu \sigma_1)$$

## Volumetric Strain on capacity

The capacity of a cylinder  $\frac{\pi}{4}d^2L$ . If the dimension is increased by  $\delta d$  and  $\delta L$ , the volumetric strain

$$\begin{aligned} &= \frac{(d + \delta d)(L + \delta L) - d^2L}{d^2L} \\ &= \frac{[d^2L + d^2\delta L + 2\delta d.dL + 2\delta d.d.\delta L + \delta d^2L + \delta d^2\delta Ld^2L]}{d^2L} \\ &= (d^2\delta L + 2\delta d.dL) / d^2L \\ &= 2.\delta d / d + \delta L / L \\ &= 2 \times \text{diametral strain} + \text{longitudinal strain} \\ &= 2 \times \text{hoop strain} + \text{longitudinal strain} \end{aligned}$$

Change in volume =  $(2\varepsilon_1 + \varepsilon_2)$  volume

For spherical shell, volume strain = 3 x hoop strain

Change in diameter =  $\varepsilon_1.d$

Change in length =  $\varepsilon_2.L$

### Example – 1

A gas cylinder of internal diameter 40mm is 5mm thick, if the tensile stress in the material is not to exceed 30 MPa, find the maximum pressure which can be allowed in the cylinder.

Data given

$$D = 40\text{mm}, t = 5\text{m}$$

$$\sigma_1 = 30\text{MPa} = 30 \text{ N/mm}^2$$

### Solution

$$\text{we know, } \sigma_1 = \frac{Pd}{2t}$$

$$\begin{aligned} \text{or, } 30 &= \frac{P \times 40}{2 \times 5} \\ &= P = 7.5\text{MPa} \end{aligned}$$

### Example – 2

A cylindrical thin drum 80mm diameter and 4m long is made 10mm thick plates. If the drum is subjected to an internal pressure of 2.5MPa determine its changes in diameter and length.  $E = 200\text{GPa}$ .

Data given

$$d = 80 \text{ mm}$$

$$L = 4\text{m}$$

$$T = 10\text{mm}$$

$$P = 2.5 \text{ N/mm}^2$$

$$E = 200 \times 10^3 \text{ N/mm}^2$$

### Solution

$$\epsilon_1 = \frac{Pd}{4tE}(2 - \mu)$$

$$\epsilon_1 = \frac{2.5 \times 800}{4 \times 10 \times 200 \times 10^3}(2 - 0.25)$$

$$\begin{aligned}\delta d &= \epsilon_1 \times d = \frac{2.5 \times 800^2}{4 \times 200 \times 10^3} \times 1.75 \\ &= 0.35 \text{ mm (Ans)}\end{aligned}$$

### Change in length

$$\epsilon_2 = \frac{Pd}{2tE}\left(\frac{1}{2} - \mu\right)$$

$$\delta L = \epsilon_2 L$$

$$= \frac{PdL}{2tE}\left(\frac{1}{2} - \mu\right)$$

$$= \frac{2.5 \times 800 \times 4 \times 10^3}{4 \times 10 \times 200 \times 10^3}\left(\frac{1}{2} - 0.25\right)$$

$$= 0.5 \text{ mm (Ans)}$$

### Example – 3

A cylindrical vessel 2m long and 500mm dia with 10mm thick plates is subjected to an internal pressure of 3MPa, calculate the change in volume of the vessel.

$$E = 200 \text{ GPa}, \mu = 0.3$$

### Data given

$$L = 2 \times 10^3 \text{ mm}$$

$$d = 500 \text{ mm}$$

$$t = 10 \text{ mm}$$

$$P = 3 \text{ MPa}$$

$$E = 200 \times 10^3 \text{ N/mm}^2$$

$$\epsilon_2 = \frac{Pd}{2tE}\left(\frac{1}{2} - \mu\right)$$

$$= \frac{3 \times 500}{2 \times 10 \times 200 \times 10^3}\left(\frac{1}{2} - 0.3\right)$$

$$= 0.075 \times 10^{-3}$$

$$V = \frac{\pi}{4} d^2 L = \frac{\pi}{4} \times 500^2 \times 2 \times 10^3$$

$$= 392.2 \times 10^6 \text{ mm}^3$$

Change in Volume

$$= V(2\epsilon_1 - \epsilon_2)$$

$$= 392.7(2 \times 0.32 \times 10^{-3} + 0.075 \times 10^{-3})$$

$$= 185 \times 10^{-3} \text{ mm}^3$$

CHAPATER. 3.0

**TWO DIMENSION STRESS SYSTEMS**

**3.1 Determination of normal stress, shear stress and resultant stress on oblique plane.**

In many instances, however, both direct and shear stresses are brought into play, and the resultants stress across any section will be neither normal nor tangential to the plane.

If  $\sigma_r$  Is the resultants stress making an angle  $\gamma$  with the normal to the plane on which of acts.

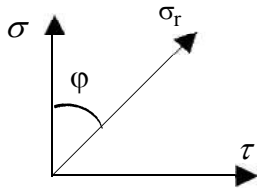

Fig 3.1

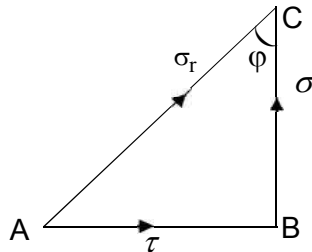

Fig 3.2

$$\phi = \tan^{-1} \frac{\tau}{\sigma}$$

$$\sigma_r = \sqrt{\sigma^2 + \tau^2}$$

**Stress on oblique plane**

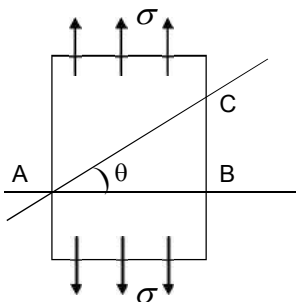

Fig 3.3

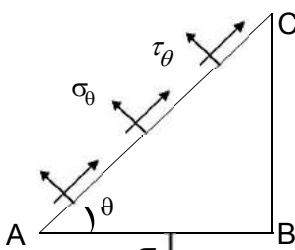

Fig 3.4

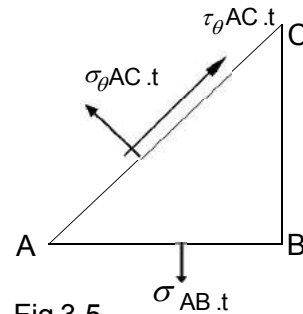

Fig 3.5

The problem is to find the stress acting on any plane AC at an angle  $\theta$  to AB. This stress will not be normal to the plane, and may be resolved into two components  $\sigma_\theta$  and  $\tau_\theta$ .

As per Figure 3.4 show the stresses acting on the three planes of the triangular prism ABC. There can be no stress on the plane BC, which is a longitudinal plane of the bar, the stress  $\tau_\theta$  must be up the plane for equilibrium.

Figure 3.5 shows the forces acting on the prism, taking a thickness t perpendicular the figure.

The equations of equilibrium resolve in the direction of  $\sigma_\theta$ .

$$\sigma_\theta \cdot AC \cdot t = \sigma_{AB} \cdot t \cos \theta$$

$$= \sigma_\theta = \sigma \left( \frac{AB}{AC} \right) \cos \theta$$

$$= \sigma \cos^2 \theta$$



Resolve in the direction  $\tau_\theta$

$$\tau_\theta \cdot AC \cdot t = \sigma \cdot AB \cdot t \sin \theta$$

$$\Rightarrow \tau_\theta = \sigma \left( \frac{AB}{AC} \right) \sin \theta$$

$$\Rightarrow \tau_\theta = \sigma \cos^2 \theta \sin \theta$$

$$\Rightarrow \tau_\theta = \frac{1}{2} \sigma \sin 2\theta$$

$$\Rightarrow \sigma_r = \sqrt{(\sigma_\theta^2 + \tau_\theta^2)}$$

$$\Rightarrow \sigma_r = \sqrt{\cos^4 \theta + \cos^2 \theta \sin^2 \theta}$$

$$\therefore \sigma_r = \sigma \cos \theta$$

It is seen that maximum shear stress is equal to one-half the applied stress and acts on planes at  $45^\circ$  to it.

### Pure Shear

As the figures will always be right-angled triangles there will be no loss of generality by assuming the hypotenuse to be of unit length. By making use of these specification it will be found that the area on which the stresses act are proportional to 1 (for AC),  $\sin \theta$  (for BC) and  $\sin \theta$  (for AB) and future figures will show the forces acting on such an element.

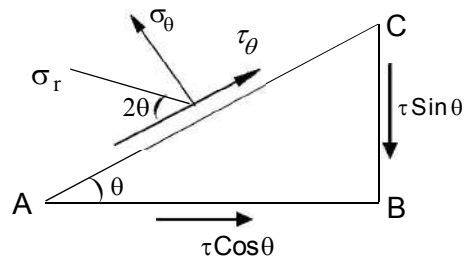

Let  $\tau$  act on a plane AB and there is an equal complementary shear stress on plane BC. The aim is to find  $\sigma_\theta$  &  $\tau_\theta$  acting on AC at an angle  $\theta$  to AB.

Resolving in the direction of  $\sigma_\theta$

$$\begin{aligned} \sigma_\theta \times 1 &= (\tau \cos \theta) \sin \theta + (\tau \sin \theta) \cdot \cos \theta \\ &= \tau \sin 2\theta \end{aligned}$$

Resolving in the direction of  $\tau_\theta$

$$\begin{aligned} \tau_\theta \times 1 &= (\tau \sin \theta) \sin \theta - (\tau \cos \theta) \cdot \cos \theta \\ &= -\tau \cos 2\theta \quad (\theta < 45^\circ) \text{ down to plane} \end{aligned}$$

$$\sigma_r = \sqrt{\sigma_\theta^2 + \tau_\theta^2} = \tau \text{ at } 2\theta \text{ to } \tau_\theta$$

### Pure Normal stresses on give planes

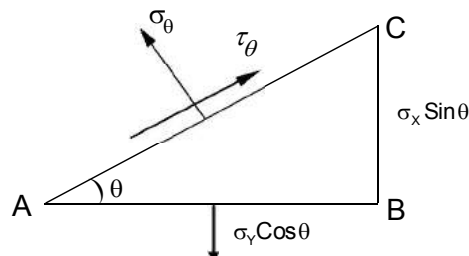

Let the known stresses be  $\sigma_x$  on BC and  $\sigma_y$  on AB, then the forces on the element are proportional to those shown.

Resolving in the direction of  $\sigma_\theta$

$$\therefore \sigma_\theta = \sigma_y \cos^2\theta + \sigma_x \sin^2\theta$$

Resolving in the direction of  $\tau_\theta$

$$\tau_\theta = \sigma_y \cos\theta \sin\theta - \sigma_x \sin\theta \cos\theta$$

$$\therefore \tau_\theta = \frac{1}{2}(\sigma_y - \sigma_x) \sin 2\theta$$

### General two dimensional Stress system

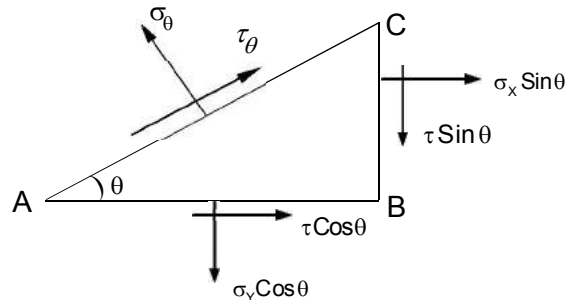

Resolving in the direction of  $\sigma_\theta$

$$\begin{aligned} \sigma_\theta &= \sigma_y \cos\theta \cos\theta + \sigma_x \sin\theta \sin\theta + \tau \cos\theta \sin\theta + \tau \sin\theta \cos\theta \\ &= \sigma_y \left(\frac{1 + \cos^2\theta}{2}\right) + \sigma_x \left(\frac{1 - \cos^2\theta}{2}\right) + \tau \sin^2\theta \\ &= \frac{1}{2}(\sigma_y + \sigma_x) + \frac{1}{2}(\sigma_y - \sigma_x) \tau \cos^2\theta + \tau \sin^2\theta \end{aligned}$$

Resolving in the direction of  $\tau_\theta$

$$\begin{aligned} \tau_\theta &= \sigma_y \cos\theta \sin\theta - \sigma_x \sin\theta \cos\theta \\ &\quad - \tau \cos\theta \cos\theta + \tau \sin\theta \sin\theta \\ \therefore \tau_\theta &= \frac{1}{2}(\sigma_y - \sigma_x) \sin 2\theta - \tau \cos 2\theta \end{aligned}$$

### Example – 1

If the stress on two perpendicular planes through a point are 60 N/mm<sup>2</sup> tension, 40 N/mm<sup>2</sup> compression and 30 N/mm<sup>2</sup> shear find the stress components and resultant stress on a plane at 60° to that of the tensile stresses.

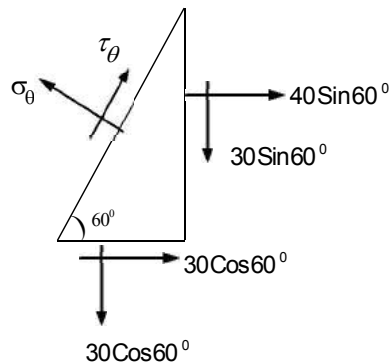

## Resolving

$$\begin{aligned}\sigma_{\theta} &= 60 \cos 60^{\circ} \cdot \cos 60^{\circ} - 40 \sin 60^{\circ} \cdot \sin 60^{\circ} + 30 \cos 60^{\circ} \sin 60^{\circ} + 30 \sin 60^{\circ} \cos 60^{\circ} \\ &= 60 \times \frac{1}{2} \times \frac{1}{2} - 40 \times \frac{\sqrt{3}}{2} \times \frac{\sqrt{3}}{2} + 30 \times \frac{1}{2} \times \frac{\sqrt{3}}{2} + 30 \times \frac{\sqrt{3}}{2} \times \frac{1}{2} \\ &= 15 - 30 + 7.5\sqrt{3} + 7.5\sqrt{3} \\ &= \sigma_{\theta} = 11 \text{ N/mm}^2\end{aligned}$$

and

$$\begin{aligned}\tau_{\theta} &= 60 \cos 60^{\circ} \cdot \sin 60^{\circ} + 40 \sin 60^{\circ} \cdot \cos 60^{\circ} - 30 \cos 60^{\circ} \cos 60^{\circ} + 30 \sin 60^{\circ} \sin 60^{\circ} \\ &= 15\sqrt{3} + 10\sqrt{3} - 7.5 + 22.5 \\ &= 58.3 \text{ N/mm}^2 \\ &= \sigma_r = \sqrt{(11^2 + 58.3^2)} = 59.3 \text{ N/mm}^2\end{aligned}$$

at angle to the

$$\gamma = \tan^{-1} \frac{58.3}{11} = 80^{\circ} 15'$$

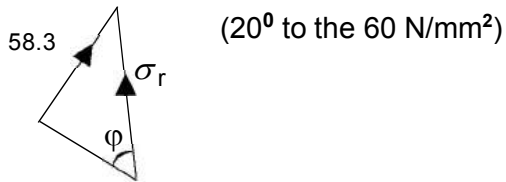

## Principal Planes

From equation

$$\tau_{\theta} = \frac{1}{2} (\sigma_y - \sigma_x) \sin 2\theta - \tau \cos 2\theta$$

There are values of  $\theta$  for which  $\tau_{\theta}$  is zero and the plane on which the shear component is zero are called principal planes.

From equation above.

$$\tan 2\theta = \frac{2\tau}{(\sigma_y - \sigma_x)} \quad (\text{when } \tau_{\theta} = 0)$$

This gives two values of  $2\theta$  differing by  $180^{\circ}$  and hence two values of  $\theta$  differing by  $90^{\circ}$  i.e. the principle planes are two planes at right angles.

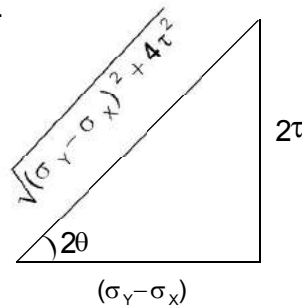

$$\sin 2\theta = \pm \frac{2\tau}{\sqrt{(\sigma_y - \sigma_x)^2 + 4\tau^2}}$$

$$\cos 2\theta = \pm \frac{\sigma_y - \sigma_x}{\sqrt{(\sigma_y - \sigma_x)^2 + 4\tau^2}}$$

## Principal Stresses

The stresses on the principal planes will be pure normal (tension or compression) and their values are called the principal stresses.

We know,

$$\sigma_{\theta} = \frac{1}{2}(\sigma_y + \sigma_x) + \frac{1}{2}(\sigma_y - \sigma_x) \cos 2\theta + \tau \sin 2\theta$$

Principal stresses =

$$\begin{aligned} & \frac{1}{2}(\sigma_y + \sigma_x) \pm \frac{\frac{1}{2}(\sigma_y - \sigma_x)^2}{\sqrt{(\sigma_y - \sigma_x)^2 + 4\tau^2}} \\ & \pm \frac{\tau \cdot 2\tau}{\sqrt{(\sigma_y - \sigma_x)^2 + 4\tau^2}} \\ & = \frac{1}{2}(\sigma_y + \sigma_x) \pm \frac{\frac{1}{2}[(\sigma_y - \sigma_x)^2 + 4\tau^2]}{\sqrt{(\sigma_y - \sigma_x)^2 + 4\tau^2}} \\ & = \frac{1}{2}(\sigma_y + \sigma_x) \pm \frac{1}{2}\sqrt{(\sigma_y - \sigma_x)^2 + 4\tau^2} \end{aligned}$$

### Shorter method for principal stresses

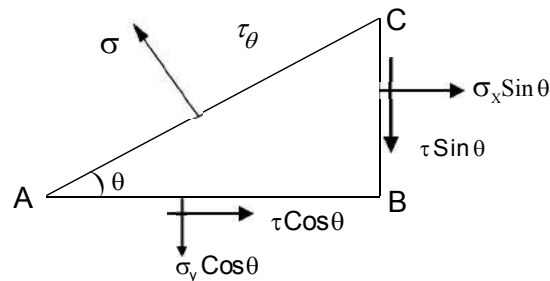

Let AC be a principal plane and  $\sigma$  the principal stress acting on it,  $\sigma_x$ ,  $\sigma_y$  and  $\tau$  are the known stress on planes BC and AB as before.

Resolve in the direction of  $\sigma_x$

$$\sigma \sin \theta = \sigma_x \sin \theta + \tau \cos \theta$$

$$\text{or } \sigma - \sigma_x = \tau \cot \theta \dots (1)$$

Resolve in the direction of  $\sigma_y$

$$\sigma \cos \theta = \sigma_y \cos \theta + \tau \sin \theta$$

$$\text{or } \sigma - \sigma_y = \tau \tan \theta \dots (2)$$

Multiply corresponding sides of equations (1) and (2) i.e.

$$(\sigma - \sigma_x)(\sigma - \sigma_y) = \tau^2$$

$$\text{or } \sigma^2 - (\sigma_x + \sigma_y)\sigma + \sigma_x \sigma_y - \tau^2 = 0$$

Solving

$$ax^2 + bx + c = 0$$

$$x = \frac{-b \pm \sqrt{b^2 - 4ca}}{2a}$$

Here

$$\sigma = \frac{(\sigma_x + \sigma_y) \pm \sqrt{(\sigma_x + \sigma_y)^2 - 4\sigma_x \sigma_y + 4\tau^2}}{2}$$

$$\text{or } \sigma = \frac{1}{2}(\sigma_x + \sigma_y) \pm \frac{1}{2}\sqrt{(\sigma_x - \sigma_y)^2 + 4\tau^2}$$

The values of  $\theta$  for the principal planes are of course found by substitution of the principal stresses values in equation (1) & (2).

## Maximum shear stress

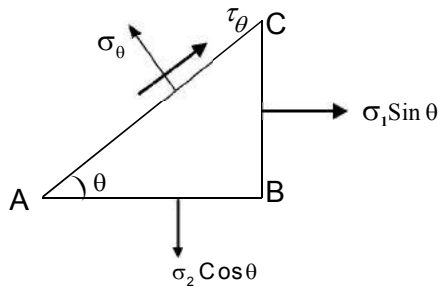

Let AB and BC be the principal planes and  $\sigma_1$  and  $\sigma_2$  the principal stresses.

Then resolve

$$\begin{aligned}\tau_\theta &= \sigma_2 \cos\theta \cdot \sin\theta - \sigma_1 \sin\theta \cdot \cos\theta \\ &= \frac{1}{2}(\sigma_2 - \sigma_1)\sin 2\theta\end{aligned}$$

Hence the maximum shear stress occurs when  $2\theta = 90^\circ$  i.e. on planes at  $45^\circ$  to the principal planes and its magnitude is

$$\begin{aligned}\tau_{\max} &= \frac{1}{2}(\sigma_2 - \sigma_1) \\ &= \frac{1}{2}\sqrt{[(\sigma_x - \sigma_y)^2 + 4\tau^2]}\end{aligned}$$

In words : The maximum shear stress is one-half the algebraic difference between the principal stresses.

### Example – 2

At a section in a beam the tensile stress due to bending is  $50 \text{ N/mm}^2$  and there is a shear stress of  $20 \text{ N/mm}^2$ . Determine from first principles the magnitude and direction of the principal stresses and calculate the maximum shear stress.

### Solution

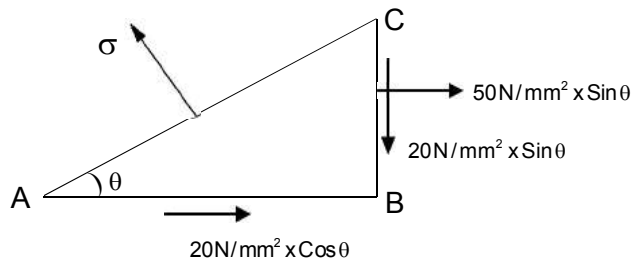

Resolve in the direction AB :

$$\sigma \sin\theta = 50 \sin\theta + 20 \cos\theta$$

$$\sigma - 50 = 20 \cot\theta \dots\dots(1)$$

Resolve in the direction BC :

$$\sigma \cos\theta = 20 \sin\theta \dots\dots(2)$$

$$\sigma = 20 \tan\theta$$

Multiplying corresponding sides of equations (i) and (ii)

$$\sigma(\sigma - 50) = 20^2$$

$$\sigma^2 - 50\sigma - 400 = 0$$

$$\sigma = \frac{50 \pm 10\sqrt{(25 - 16)}}{2}$$

$$= \frac{50 \pm 64}{2} = 57 \text{ or } -7$$

i.e. the principal stresses are  $57 \text{ N/mm}^2$  tension,  $7 \text{ N/mm}^2$  compression,

$$\tan \theta = \frac{\sigma}{\tau} = \frac{57}{20} \text{ or } \frac{-7}{20}$$

Giving  $\theta = 70^\circ$  and  $160^\circ$ , being the directions of the principal planes.

Max shear stress =

$$\begin{aligned} &= \frac{1}{2}(\sigma_2 - \sigma_1) \\ &= \frac{1}{2}[57 - (-7)] \\ &= 32 \text{ N/mm}^2 \end{aligned}$$

and the planes of maximum shear are at  $45^\circ$  to be principle planes i.e.  $\theta = 25^\circ$  and  $115^\circ$ . (Ans)

### Maximum shear stress using Mohr's Circle

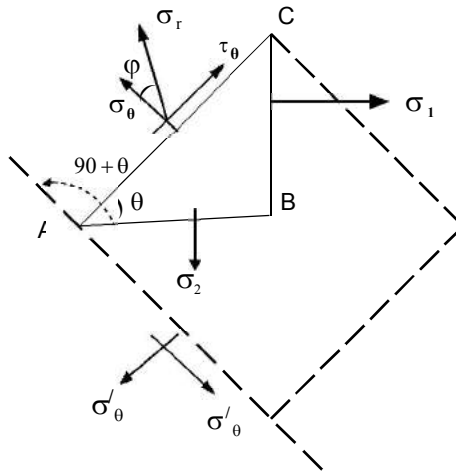

The stress circle will be developed to find the stress components on any plane AC which makes an angle  $\theta$  with AB.

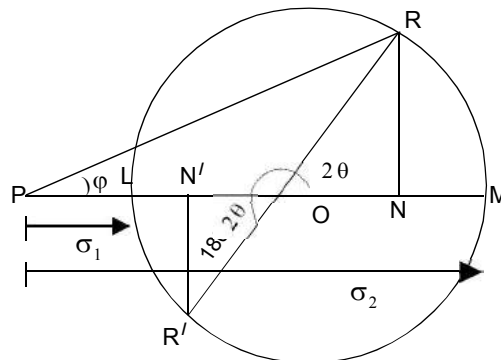

### Construction

Mark off  $PL = \sigma_1$  and  $PM = \sigma_2$  (positive direction to the right). It is shown here for  $\sigma_2 > \sigma_1$ , but this is not a necessary condition. On LM as diameter describes a circle center O.

Then the radius OL represents the plane of  $\sigma_1$  (BC) and OM represents the plane of  $\sigma_2$  (AB) plane AC is obtained by rotating AB through  $\theta$  anticlockwise, and if OM on the stress circle is rotated through  $2\theta$  in the same direction, the radius OR is obtained which will be shown to represent the plane AC.

OR could equally be obtained by rotating OL clockwise through  $180^\circ - 2\theta$ , corresponding to rotating BC clockwise through  $90^\circ - \theta$ .

Draw  $RN \perp r$  to  $PM$

Then  $PN = PO + ON$

$$\begin{aligned} &= \frac{1}{2}(\sigma_1 + \sigma_2) + \frac{1}{2}(\sigma_2 - \sigma_1)\cos 2\theta \\ &= \sigma_1 \frac{(1 - \cos 2\theta)}{2} + \sigma_2 \frac{(1 + \cos 2\theta)}{2} \\ &= \sigma_1 \sin^2 \theta + \sigma_2 \cos^2 \theta = \sigma_\theta, \text{ the normal stress component on AC} \end{aligned}$$

$$\begin{aligned} \text{and } RN &= \frac{1}{2}(\sigma_2 - \sigma_1)\sin 2\theta \\ &= \tau_\theta, \text{ the shear stress component on AC} \end{aligned}$$

Also the resultant stress

$$= \sigma_r = \sqrt{(\sigma_\theta^2 + \tau_\theta^2)} = PR$$

And its inclination to the normal of the plane is given  $\phi = \angle RPN$

$\sigma_\theta$  is found to be a tensile stress and  $\tau_\theta$  is considered positive if  $R$  is above  $PM$ ,

The stresses on the plane  $AD$ , at right angles for  $AC$ , are obtained from the radius  $OR'$ , at  $180^\circ$  to  $OR$

$$\text{i.e. } \sigma_\theta^1 = PN^1, \tau_\theta^1 = R^1N^1$$

and  $\tau_\theta = \tau_\theta^1$  but of opposite type, tending to give an anticlockwise rotation.

The maximum shear stress occurs when  $RN = OR$ , i.e.  $\theta = 45^\circ$  and is equal in magnitude to  $OR = \frac{1}{2}(\sigma_2 - \sigma_1)$ . The maximum value of  $\phi$  is obtained when  $PR$  is a tangent to the stress circle.

Two particular cases which have previously been treated analytically will be dealt with by this method.

### 1. Pure compression

IF  $\sigma$  is the compressive stress the other principal stress is zero.

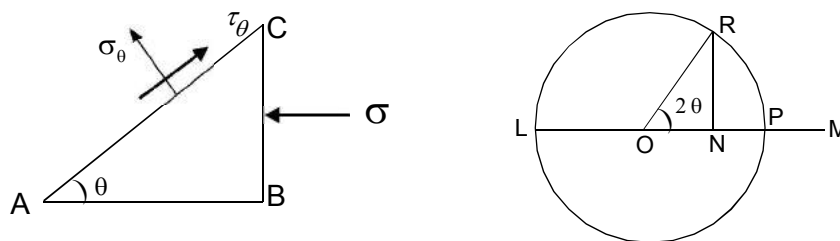

$PL = \sigma$  numerically, measured to the left for compression,  $PM = 0$

$$\begin{aligned} \text{Hence, } OR &= \frac{1}{2}\sigma \\ \sigma_\theta &= PN, \text{ Compressive} \\ \tau_\theta &= PN, \text{ Positive} \end{aligned}$$

Maximum shear stress =  $OR = \frac{1}{2}\sigma$  occurring when  $\theta = 45^\circ$ .

## 2. Principal stresses equal tension and compression

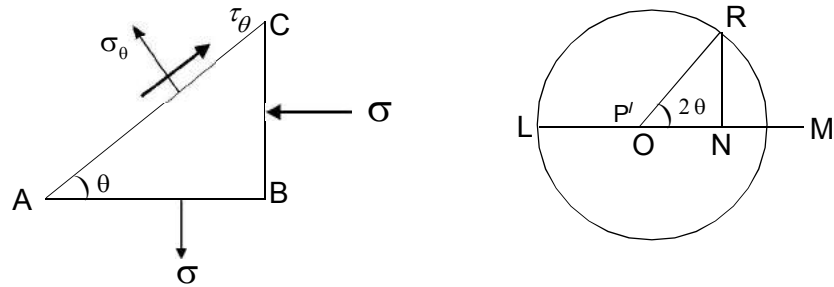

PM =  $\sigma$  to the right

PL =  $\sigma$  to the left

Here O coincides with P

$\sigma_\theta = PN$ , is tensile for

$\theta$  between  $\pm 45^\circ$ , compressive for

$\theta$  between  $45^\circ$  and  $135^\circ$

$\tau_\theta = RN$ , when  $\theta = 45^\circ$

$\tau_\theta$  reach maximum =  $\sigma$ , on planes when the normal stress is zero (Pure shear)

### Example -3

A piece of materials is subjected to two compressive stresses at right angles, their values being  $40 \text{ N/mm}^2$  and  $60 \text{ N/mm}^2$ . Find the position of the plane across which the resultant stress is most inclined to the normal and determine the value of this resultant stress.

### Solution

$\sigma_1 = 60 \text{ N/mm}^2$  (Compressive)

$\sigma_2 = 40 \text{ N/mm}^2$  (Compressive)

In the figure, the angle  $\theta$  is inclined to the plane of the  $40 \text{ tons N/m}^2$  compression.

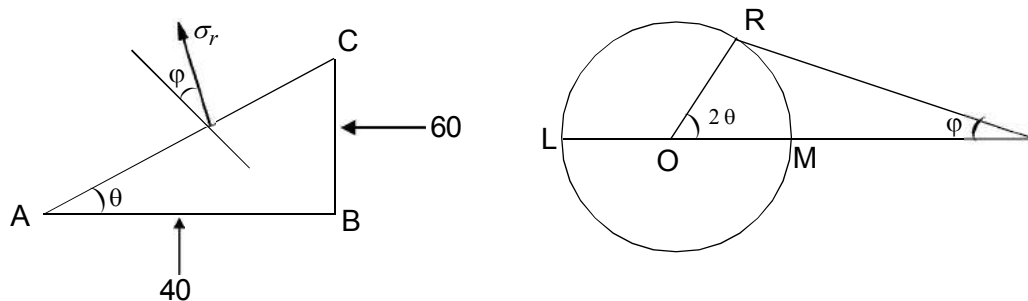

In above figure  $PL = 60$ ,  $PM = 40$ , The maximum angle  $\phi$  is obtained when PR is a tangent to the stress circle.

OR = 10, PO = 50

Then  $\phi = \sin^{-1} \frac{1}{5} = 11^\circ 30'$

$\sigma_r = PR = -\sqrt{(50^2 - 10^2)} = -49 \text{ N/mm}^2$

$2\theta = 90 - \phi$

$\theta = 39^\circ 15'$

which gives the plane required



### Example -4

At a point in a piece of elastic material there are three mutually perpendicular planes on which the stresses are as follows : tensile stress 50 N/mm<sup>2</sup>, shear stress 40 N/mm<sup>2</sup> on plane, compressive stress 35 N/mm<sup>2</sup> and complementary shear stress 40 N/mm<sup>2</sup> on the second plane, no stress on the third plane. Find (a) the principal stresses and the positions of the plane on which they act (b) the position of the planes on which there is no normal stress.

Solution

Mark off PN = 50, NR = 40

$PN' = -35, N'R' = -40$

Join  $RR'$ , Cutting  $NN'$  at O, Draw circle centre O, radius OR

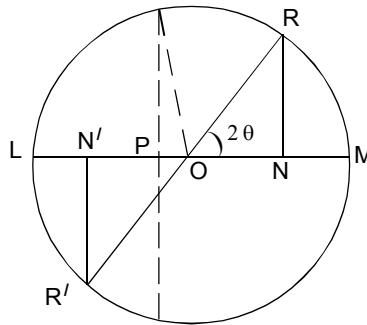

$$\begin{aligned} \text{Then } ON &= \frac{1}{2} NN' \\ &= 42.5 \end{aligned}$$

$$\begin{aligned} OR &= \sqrt{42.5^2 + 40^2} = 58.4 \\ PO &= PN - ON = 7.5 \end{aligned}$$

(a) The Principal stresses are

$$PM = PO + OM = 6.5 \text{ N/mm}^2 \text{ (tensile)}$$

$$PL = OL - OP = 50.9 \text{ N/mm}^2 \text{ (compressure)}$$

$$\text{or, } 2\theta = \tan^{-1} \frac{40}{42.5} = 43^\circ 20'$$

$$\Rightarrow \theta = 21^\circ 40'$$

(b) If there is no normal stress, then for that plane N and P coincides and

$$2\theta = 180 - \cos^{-1} \frac{7.5}{58.4}$$

$$2\theta = 97^\circ 24'$$

$$\theta = 48^\circ 42' \text{ to the principal plane}$$

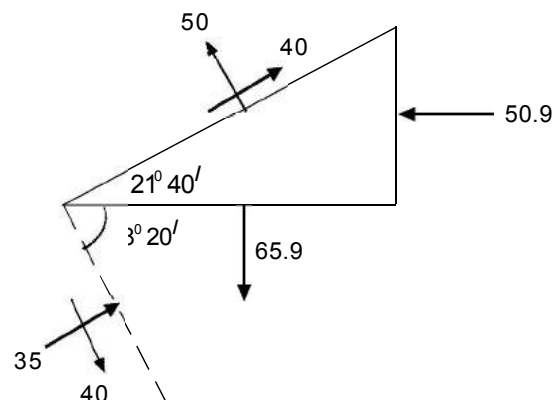

## CHAPTER 4.0

# SHEAR FORCE & BENDING MOMENT

### 4.1 – Types of beam and load

#### Beam

A structural member which is acted upon by a system of external loads at right angles to its axis is known as beam.

#### Types of Beam

1. Cantilever beam
2. Simply supported beam
3. Over hanging beam
4. Rigidity fixed or built in beams
5. Continuous beam

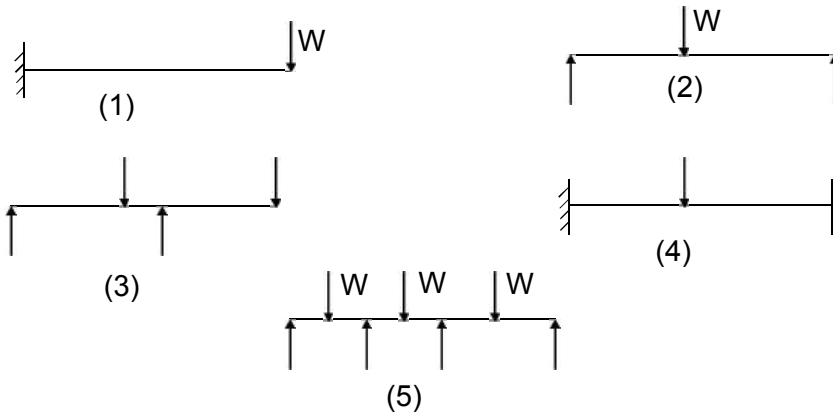

#### Types of load

1. Concentrated or point load
2. Uniformly distributed load
3. Uniformly varying load



### 4.2. Concepts of share force and bending moment

#### Shear force

The shearing force at any section of beam represents the tendency for the portion of beam to one side of the section of slide or shear laterally relative to the other portion.

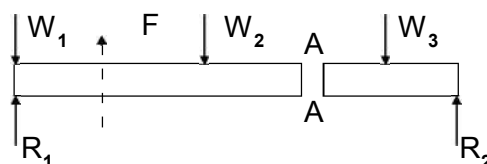

The resultant of the loads and reactions to the left of A is vertically upwards and the since the whole became is in equilibrium, the resultant of the forces to the right of AA must also be F acting down ward. F is called the shearing force.

## Definition

The shearing force at any section of a beam is the algebraic sum of the lateral component of the forces on either side of the section.

Shearing force will be considered positive when the resultant of the forces to the left is upwards or to the right in downward.

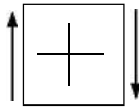

A shear force diagram is one which shows the variation of shearing force along the length of the beam.

## Concepts of Bending Moment

In a small manner it can be argued that if the moment about the section AA of the forces to the left is  $M$  clockwise then the moment of the forces to the right of AA must be anticlockwise.  $M$  is called the bending moment.

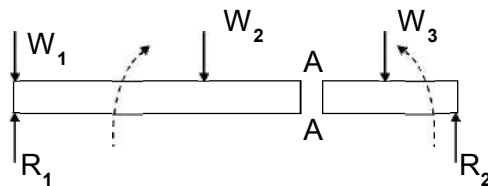

## Definition

The algebraic sum of the moments about the section of all the forces acting on other side of the section.

Bending moment will be considered positive when the moment on the left of section is clockwise and on the right portion anticlockwise. This is referred as sagging the beam because concave upwards. Negative B.M is termed as hogging. A BMD is one which shows the variation of bending moment along the length of the beam.

### **4.3 Shear force and bending moment diagram and its silent features.**

- i. Illustration in cantilever beam
- ii. Illustration in simply supported beam
- iii. Illustration in overhang beam

Carrying point load and u.d.L.

## Concentrated loads

### **Example -1**

A cantilever of length  $L$  carries a concentrated load  $W$  at its free end, draw the SF & BM diagram.

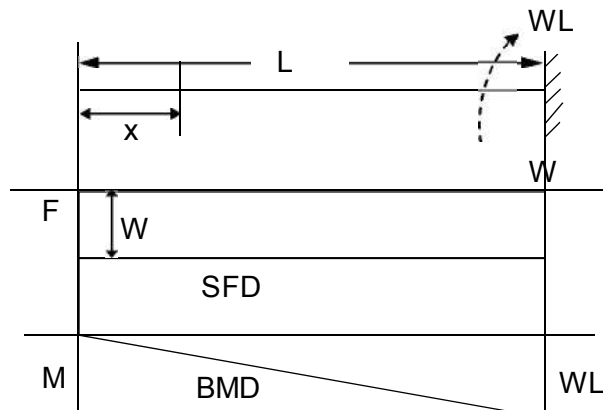

## Solution

At a section a distance  $x$  from the free end, consider the forces to the left.

Then  $F = -W$ , and is constant along the whole beam for all values of  $x$ . Taking moments about the section given  $M = -Wx$

At  $x = 0$ ,  $M = 0$ , At  $x = L$ ,  $M = -WL$

At end from equilibrium condition the fixing moment is  $WL$  and reactions  $W$ .

## **Example – 2**

A beam 10m long is simply supported at its ends and carries concentrated loads of 30 KN and 50 KN at distance of 3m from each end. Draw the SF & BM diagram.

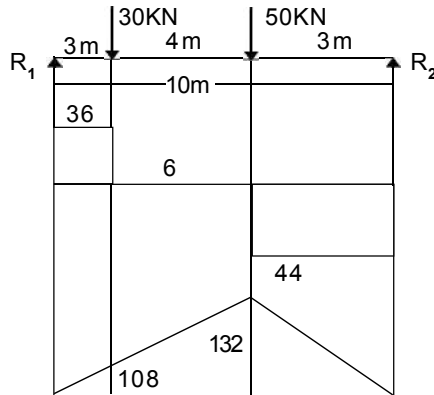

## Solution

First calculate  $R_1$  and  $R_2$  at support

$$R_1 \times 10 = 30 \times 7 + 50 \times 3$$

$$= R_1 = 36 \text{KN}$$

$$\text{and } R_2 = 30 + 50 - 36 = 44 \text{KN}$$

Let  $x$  be the distance of the section from the left hand end.

## Shearing force

$$0 < x < 3\text{m}, F = 36 \text{KN}$$

$$3 < x < 7, F = 36 - 30 = 6 \text{KN}$$

$$7 < x < 10, F = 36 - 30 - 50 = -44 \text{KN}.$$

## Bending moment

$$0 < X < 3, M = R_1 X = 36 x \text{KNM}$$

$$3 < X < 7, M = R_1 X - 30 (X-3) = 6X + 90 \text{KNM}$$

$$Kx < 10, 7, M = R_1 X - 30 (X-3) - 50 (X-7) = 44 X + 440 \text{KNM}$$

Principal values of  $M$  are

$$\text{at } X = 3\text{m}, m = 108 \text{KNM}$$

$$\text{at } x = 7\text{m}, M = 132 \text{KNM}$$

$$\text{at } x = 10, M = 0.$$

## CHAPTER 4

# BENDING MOMENT & SHEAR FORCE

### Introduction

When any structure is loaded, stresses are induced in the various parts of the structure and in order to calculate the stresses, where the structure is supported at a number of points, the bending moments and shearing forces acting must also be calculated.

### Definitions

**Beam** - Beam is structural member which is acted upon by a system of external loads at right angles to the axis.

**Bending** - Bending implies deformation of a bar produced by loads perpendicular to its axis as well as force couples acting in a plane passing through the axis of the bar.

**Plane bending** - If the plane of loading passes through one of the principal centroidal axes of the cross section of the beam, the bending is said to be plane.

**Point load** - A point load or concentrated load is one which is considered to act at a point.

**Distributed load** - A distributed load is one which is distributed or spread in some manner over the length of the beam. If the spread is uniform, it is said to be uniformly distributed load. If the spread is not at uniform rate, it is said to be non-uniformly distributed load.

### CLASSIFICATION OF BEAMS

**1. Cantilever** – A cantilever is a beam whose one end is fixed and the other end free. Fig. 4.1 shows a cantilever with a rigidity fixed into its support and the other end B free. The length between A & B is known as the length of cantilever.

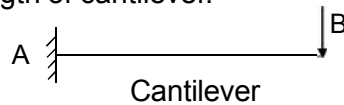

**Fig 4.1**

**2. Simply supported beam** – A simply supported beam is one whose ends freely rest on walls or columns or knife edges.

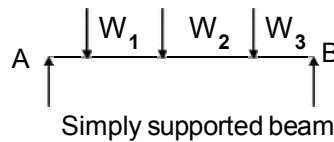

**Fig. 4.2**

**3. Over hanging beam** – An overhanging beam is one in which the supports are not situated at the ends i.e. one or both the ends project beyond the supports. In Fig. 4.3 C & D are two supports and both the ends A and B of the beam are overhanging beyond the supports C & D respectively.

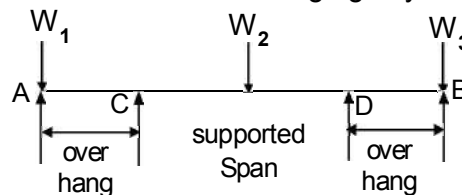

**Fig. 4.3**

**4. Fixed beam** – A fixed beam is one whose both ends are rigidly fixed or built in into its supporting walls or columns.

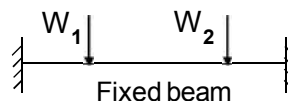

**Fig. 4.4**

**5. Continuous beam** – A continuous beam is one which has more than two supports. The supports at the extreme left and right are called the end supports and all the other supports, except the extreme, are called intermediate supports.

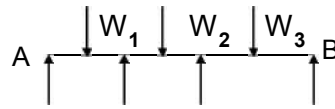

Continuous beam

**Fig. 4.5**

### SHEAR FORCE

In general if we have to calculate the shear force at a section the following procedure may be adopted.

- (i) Consider the left or the right part of the section.
- (ii) Add the forces normal to the member on one of the parts.

If the right part of the section is chosen, a force on the right part acting downwards is positive while a force on the right part acting upwards is negative. For instance, if the shear force at a section x of a beam is required and if the right part x B be considered the forces P & Q are positive while the force R is negative. S.F. at X = P + Q - R



**Fig.4.6**

If the left part of the section be chosen, a force on the left part acting upwards is positive and a force on the left part downwards is negative. For instance, if the shear force at X of a beam is required and if XA is the left part, the force Q is positive while the forces  $W_1$  &  $W_2$  are negative.

$$\therefore \text{S.F at X} = Q - W_1 - W_2$$

### BENDING MOMENT

To find the bending moment at a section of a beam the following procedure may be adopted.

- (i) Consider the left or right part of the section.
- (ii) Remove all restraints and all forces on the part selected
- (iii) Now introduce each force or reacting element one at a time and find its effect at the section (i.e. find whether the moment produces a hogging or sagging effect at the section). Treat sagging moments as positive and hogging moments as negative.

Note that the moment due to every downward force is negative and moment due to every upward force is positive.

Shear force and bending moment diagrams.

## A. CANTILEVER

(i) Cantilever of length  $L$  carrying a concentrated load  $W$  at the free end.

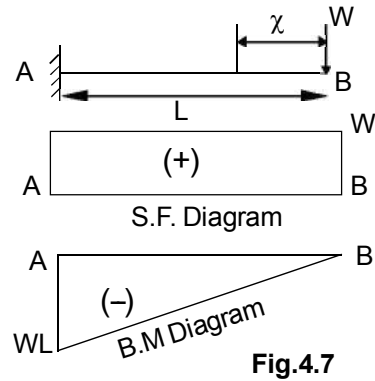

Fig.4.7

Fig. 4.7 shows a cantilever AB fixed at A and free at B and Carrying the load  $W$  at the free end B. Consider a section  $x$  at a distance of  $x$  from the free end.

$$\text{S.F at X} = S_x = +W$$

$$\text{B.M at X} = M_x = -Wx$$

Hence, we find that the S.F. is constant at all sections of the member between A & B. But the B.M at any section is proportional to the distance of the section from the free end.

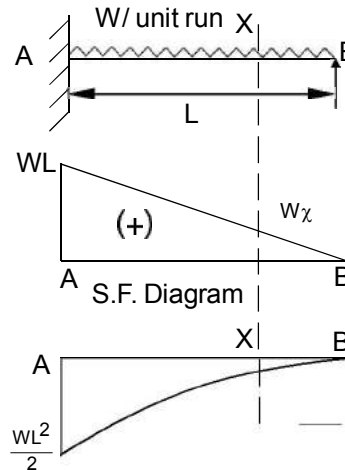

At  $x = 0$  i.e. at B, B.M = 0

At  $x = L$  i.e. at A, B.M =  $WL$

Fig. 4.7 shows the S.F. and B.M diagrams.

(ii) Cantilever of length  $L$  carrying a uniformly distributed load of  $W$  per unit run over the whole length.

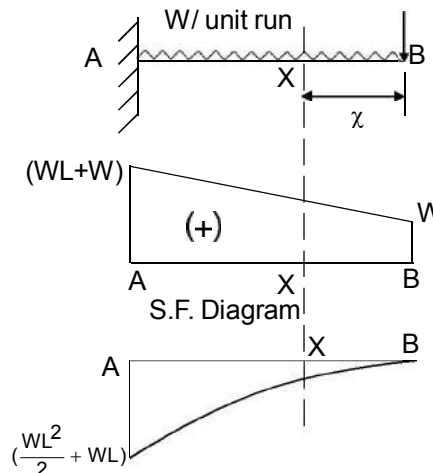

Fig 4.8 shows a cantilever AB fixed at A and free at B carrying a uniformly distributed load of  $W$  per unit run over the whole span.

Consider any section X distant  $\chi$  from the end B.

$$\text{S.F at } X = S_{\chi} = +W_{\chi}, \text{ B.M at } X = M_{\chi} = -W_{\chi} \cdot \frac{\chi}{2} = -W \cdot \frac{\chi^2}{2}$$

Hence we find that the variation of the shear force is according to a linear law while the variation of the bending moment is according to a parabolic Law.

$$\text{At } \chi = 0, S_{\chi} = 0, M_{\chi} = 0$$

$$\text{At } \chi = L, S_{\chi} = +WL, M_{\chi} = \frac{WL^2}{2}$$

(iii) Cantilever of length L carrying a uniformly distributed load of W per unit run over the whole length and a concentrated load W at the free end.

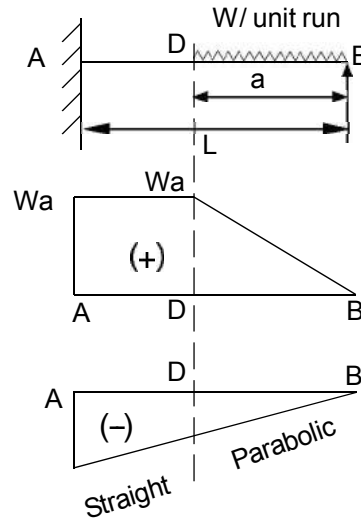

**Fig.4.10**

Fig. 4.10 Shows a cantilever AB fixed at A and free at B and carrying the load system mentioned above. Consider any section X distant  $\chi$  from the end B. The S.F and the B.M at the section X are respectively given by

$$\text{At } \chi = 0, S_{\chi} = +W, M_{\chi} = -\left(\frac{W\chi^2}{2} + WL\right)$$

$$\text{At } \chi = L, S_{\chi} = +W, M_{\chi} = 0$$

$$\text{At } \chi = L, S_{\chi} = +(WL+W), M_{\chi} = +\left(\frac{WL^2}{2} + WL\right)$$

S.F. varies following a linear law while B.M varies following a parabolic Law.

(iv) cantilever of length L carrying a uniformly distributed load of W per unit run for a distance a from the free end.

Fig. 4.10 shows a cantilever AB fixed at A and free at B and carrying the load system mentioned above.

Consider any section between D and B distant  $\chi$  from the free end B.

$$\text{S.F and B.M at the section are given by } S_{\chi} = +W_{\chi}, M_{\chi} = -\frac{W\chi^2}{2}$$

The above relations hold good for all values of x between  $\chi = 0$  and  $\chi = a$  (i.e. between B & D)

Hence for this range the S.F. varies following a linear Law while the B.M varies following a parabolic Law.

$$\text{At } \chi = 0, S_{\chi} = 0, M_{\chi} = 0$$



$$\text{At } \chi = a, S\chi = +Wa \text{ and } M\chi = -\frac{Wa^2}{2}$$

Now consider any section between D & A, distant  $\chi$  from the end B.

The S.F & B.M at this section are given by

$$S\chi = +Wa \text{ and } M\chi = -Wa\left(\chi - \frac{a}{2}\right)$$

Hence between A & D, S.F. is constant at  $+Wa$  but the B.M varies according to a linear law.

$$\text{At } \chi = a, M\chi = -Wa\left(a - \frac{a}{2}\right) = -\frac{Wa^2}{2}$$

$$\text{At } \chi = L, M\chi = -Wa\left(L - \frac{a}{2}\right)$$

### Problem

Fig. shows a cantilever subjected to a system of loads. Draw S.F & B.M diagrams.

Solution – At any section between D & E, distant  $x$  from E.

$$S.F = S\chi + 500\text{kg}$$

$$B.M = M\chi = -500\chi$$

$$\text{At } \chi = 0, M\chi = 0$$

$$\text{At } \chi = 0.5\text{m}, M\chi = -500 \times 0.5 = -250\text{kg.m}$$

At any section between C & D, distant  $\chi$  from E,

$$S.F = S\chi = +500 + 800 = +1300\text{Kg}$$

$$B.M = M\chi = -500\chi - 800(\chi - 0.5) = -1300\chi + 400$$

$$\text{At } \chi = 0.5, M\chi = -1300 \times 0.5 + 400 = -250\text{Kg.m}$$

$$\text{At } \chi = 1\text{m}, M\chi = -1300 + 400 = -900\text{Kg.m}$$

At any section between B & E, distant  $x$  from E

$$S.F = S\chi = +500 + 800 + 300 = 1600\text{Kg}$$

$$B.M = M\chi = -500\chi - 800(\chi - 0.5) - 300(\chi - 1) \text{ Kg. } M = -1600\chi + 700 \text{ Kg.m}$$

$$\text{At } \chi = 1\text{m}, M\chi = -1600 + 700 = -900 \text{ Kg.m}$$

$$\text{At } \chi = 1.5\text{m}, M\chi = -1600 \times 1.5 + 700 = -1700 \text{ Kg.m}$$

At any section between A & B distant  $x$  from E.

$$S.F = S\chi = +500 + 800 + 300 + 400 = 2000\text{Kg}$$

$$B.M = M\chi = -500\chi - 800(\chi - 0.5) - 300(\chi - 1) - 400(\chi - 1.5) = -200\chi + 1300\text{Kg.m}$$

$$\text{At } \chi = 1.5\text{m}, M\chi = -2000 \times 1.5 + 1300 = -1700\text{Kg. m}$$

$$\text{At } \chi = 2\text{m}, M\chi = -2000 \times 2 + 1300 = -2700 \text{ Kg.m}$$

Beams freely supported at the two ends.

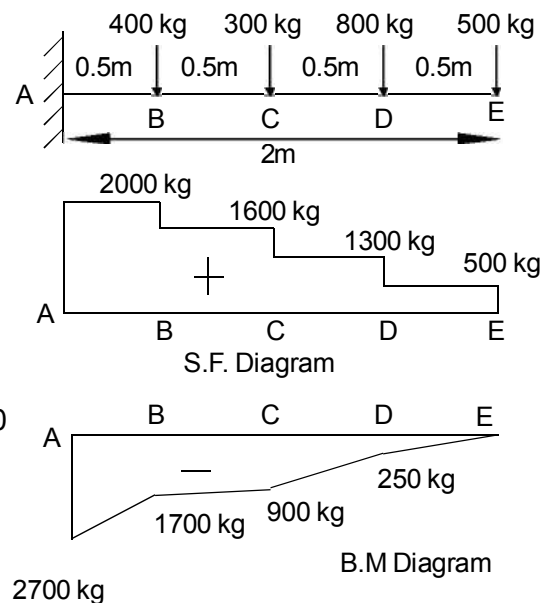

**Fig. 4.11**

(i) Simply supported beam of span L carrying a concentrated load at mid

Fig 4.12 shows a beam AB simply supported at the ends A & B. Let the span of the beam be L and let the beam carry a concentrated load W at mid span.

Since the load is symmetrically placed on the span, reaction on the span, reaction at each support =  $\frac{W}{2}$

$$\therefore R_A = R_B = \frac{W}{2}$$

For any section between A & C S.F. =  $S_x = +\frac{W}{2}$

For any section between C & B S.F. =  $S_x = -\frac{W}{2}$

At the section C the S.F changes from  $+\frac{W}{2}$  to  $-\frac{W}{2}$

At any section between A & C distant  $\chi$  from the end A, the bending moment is given by,

$$M_x = +\frac{W}{2}\chi \text{ (sagging moment)}$$

At  $\chi = 0$ ,  $M_x = 0$

$$\text{At } \chi = \frac{L}{2}, M_x = \frac{WL}{4}$$

Hence the B.M increased uniformly from zero at A to  $\frac{WL}{4}$  at C.

Similarly the B.M decreases uniformly from  $\frac{WL}{4}$  at C to zero at B. Maximum bending moment occurs at mid span i.e. at C where the S.F changes its sign.

(ii) Simply supported beam carrying a concentrated load placed eccentrically on the span.

Fig. 4.13 shows a simply supported beam AB of span L carrying a concentrated load W at D eccentrically on the span.

Let AD = a & DB = b

Let  $R_a$  &  $R_b$  be the vertical reactions at A & B

For equilibrium of the beam,

Taking moments of the forces on the beam about A, we have

$$R_b = Wa$$

$$\therefore R_b = \frac{Wa}{L}$$

$$\therefore R_b = W - \frac{Wa}{L} = \frac{W(L-a)}{L}$$

$$\therefore R_a = \frac{Wb}{L}$$

Since  $a+b = L$  for any section between A and D

the shear force =  $S_x = V_a = +\frac{Wb}{L}$

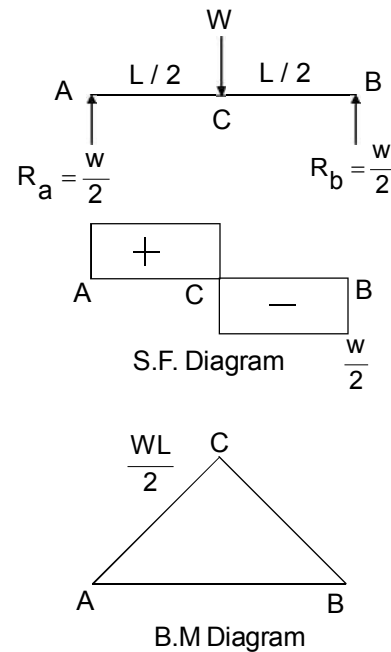

Fig. 4.12

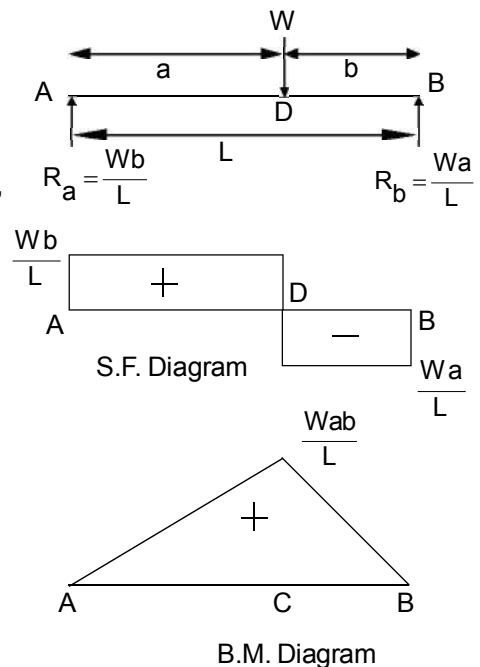

Fig. 4.13

For any section between D & B, the shear force =  $S_x = -R_b + \frac{Wb}{L}$

At any section between A & D distant x from A, the bending moment is given by

$$M_x = + \frac{Wb}{L}x \text{ (sagging)}$$

At  $x = 0$ ,  $M_x = 0$

$$\text{At } x = 0, M_x = \frac{Wab}{L}$$

Hence the B.M increases uniformly from zero at the left end A to  $\frac{Wab}{L}$  at D. Similarly the B.M

will decrease uniformly from  $\frac{Wab}{L}$  at D to zero at the right end B.

It may be observed from the S.F and B.M diagrams that the maximum B.M occurs at D where the S.F. changes its sign.

(iii) Simply supported beam carrying a number of concentrated loads.

Fig. 4.14 shows a simply supported beam AB of span 8 meters carrying concentrated loads of 4KN, 10 KN & 7 KN at distances of 1.5 meters, 4 meters & 6 meters from the left support.

S.F between C & D =  $+10 - 4 = +6\text{KN}$

S.F between D & E =  $+10 - 4 - 10 = -4\text{KN}$

S.F between E & B =  $+10 - 4 - 10 - 7 = -11\text{KN}$

B.M at A = 0

B.M at C =  $+10 \times 1.5 = +15\text{KNm}$  (Sagging)

B.M at D =  $+10 \times 4 - 4 \times 2.5 = +30 \text{ KNm}$  (Sagging)

B.M at E =  $+11 \times 2 = +22 \text{ KNM}$  (Sagging)

It may be observed from the S.F & B.M diagrams that the maximum B.M occurs at D where the S.F changes its sign.

(iv) Simply supported beam carrying a uniformly distributed load of W per unit run over the whole span.

Fig. 4.15 shows a simply supported beam AB of span L carrying a uniformly distributed load W per unit run over the whole span. Let  $R_a$  &  $R_b$  be the vertical reactions at the supports A & B respectively.

Since the loading is symmetrical on the span, each vertical reaction equals half the total load on the span.

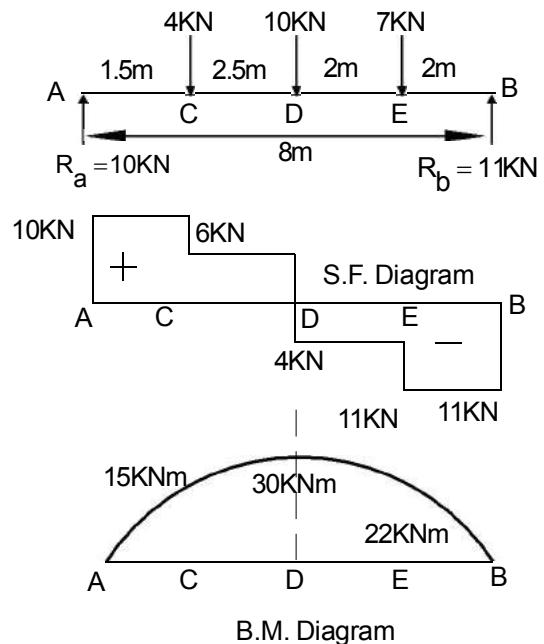

Fig. 4.14

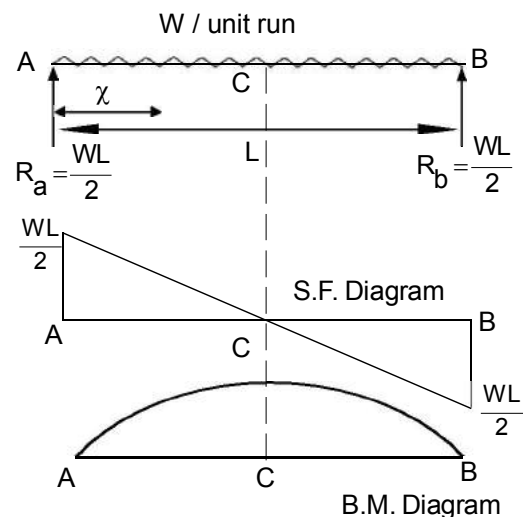

Fig. 4.15

$$\therefore R_a = R_b = \frac{WL}{2}$$

Consider any section X distant  $\chi$  from the left end A.

S.F & B.M at the section X are given by

$$S_\chi = +R_a - W\chi = +\frac{WL}{2} - W\chi$$

$$M_\chi = R_a\chi - \frac{W\chi^2}{2} = \frac{WL}{2}\chi - \frac{W\chi^2}{2}$$

$$\therefore M_\chi = +\frac{W}{2}\chi(L - \chi)$$

$$\text{At } \chi=0, S_\chi = +\frac{WL}{2}, M_\chi = 0$$

$$\text{At } \chi=L, S_\chi = +\frac{WL}{2} - WL = -\frac{WL}{2}, M_\chi = 0$$

$$\text{At } \chi = \frac{L}{2}, S_\chi = +\frac{WL}{2} - \frac{WL}{2} = 0 \text{ \& } M_\chi = +\frac{WL}{2} \cdot \frac{L}{2} \left(L - \frac{L}{2}\right) = +\frac{WL^2}{8}$$

The S.F diagram is a straight line. The S.F uniformly changes from  $+\frac{WL}{2}$  At A to  $-\frac{WL}{2}$  At B & obviously that S.F at Mid span is zero.

The B.M diagram is a parabola. The B.M increases according to a parabolic law from zero at A to  $+\frac{WL^2}{8}$  at the mid span C and from this value the B.M decreases to zero at B following the parabolic law.

(v) Beam with overhanging at one end and carrying a uniformly distributed load over the whole length.

Fig. 4.16 shows a simply supported beam ABC with supports at A & B, 6 meters apart with an overhang BC 2 meters long.

Let  $R_a$  &  $R_b$  be the vertical reactions at A & B. For the equilibrium of the beam, taking moments about A,

$$\text{we have } R_a \times 6 = 1.5 \times 8 \times 4$$

$$\therefore R_b = 8 \text{ tones}$$

$$\therefore R_a = 1.5 \times 8 - 8 = 4 \text{ tones}$$

$$\text{S.F at the left end} = +4t$$

$$\text{S.F just on the left hand side of B} = +4 - 1.5 \times 6 = -5t$$

$$\text{S.F. just on the right hand side of B} = +1.5 \times 2 = 3t$$

$$\text{S.F at C} = 0$$

Let S.F be zero at  $\chi$  meters from A,

equating the S.F to zero,

$$\text{we get } S_\chi = 4 - 1.5\chi = 0 \therefore \chi = \frac{8}{3} = 2.67m$$

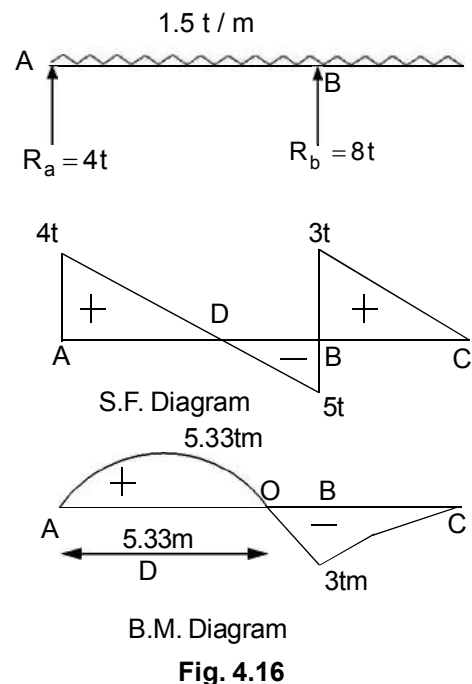

Fig. 4.16

B.M at A = 0, At any section in AB distant x from A the B.M is given by

$$M_x = 4x - 1.5 \frac{x^2}{2}$$

Hence the B.M diagram is parabolic

$$\text{B.M at } x = \frac{8}{3} \text{ MB } M_{\max} = 4 \times \frac{8}{3} - \frac{1.5}{2} \left(\frac{8}{3}\right)^2 = \frac{16}{3} + 5.33 \text{tm}$$

$$\text{B.M at } x = 6 \text{m i.e. at B} = 4 \times 6 - \frac{1.5}{2} \times 6^2 = -3 \text{tm}$$

Section at which the B.M is Zero

Since at  $x = \frac{8}{3}$  the B.M is +5.33 tm & at  $x = 6$  m the B.M is -3tm there must be a section where the B.M is zero. This section can be determined by equating the general expression for B.M to zero. i.e. by the equation

$$4x - 1.5 \frac{x^2}{2} = 0$$

$$\therefore x(4 - 0.75x) = 0$$

$$\therefore x = 0 \text{ \& \; } \therefore x = \frac{16}{3} = 5.33 \text{m}$$

Let the B.M be zero at O,  $AO = \frac{16}{3}$  m

The point O where the B.M is zero called the point of contra flexure or point of inflexion.

For all sections from A to O the B.M is of the sagging type while for all sections between O & C the B.M is of the hogging type.

(vi) A beam of length (L+2a) has supports L apart with an overhang a on each side. The beam carries a concentrated load W at each end. Draw S.F & B.M diagram.

Let DABC be the beam of length (L+2a). Let the supports be at A & B,

so that DA = BC = a

$\therefore AB = L$

Each vertical reaction = W

$\therefore R_a = R_b = W$

S.F. at any section between D & A = -W

S.F. at any section between B & C = +W

S.F. at any section between A & B = 0

B.M at D = 0 B.M at A = -Wa

At any section in AB distant x from D the B.M is given by

$$M_x = -Wx + W(x-a) = -Wa$$

B.M at B = -Wa B.M at C = 0

The B.M throughout the length is of the hogging type.

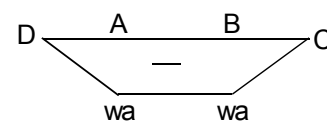
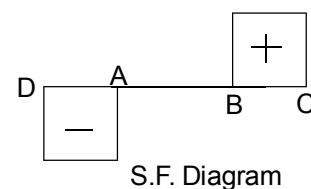
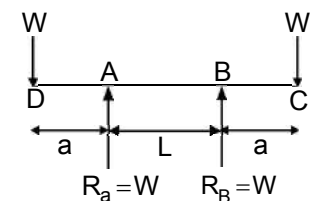

**Fig. 4.17**

## CHAPTER 5

### THEORY OF SIMPLE BENDING

When a beam is loaded it is bent and subjected to bending moments. Consequently, longitudinal or bending stresses are induced in cross section.

Assumptions in 'Theory of bending'

1. The material of the beam is perfectly homogenous
2. The stress induced is proportional to the strain & the stress should not exceed the elastic limit.
3. The value of modulus of elasticity (E) is same, for the fibres of the beam under compression or tension.
4. The transverse section of the beam, which is plane before bending, remains plane after bending.
5. There is no resultant pull or push on the cross section of the beam
6. The loads are applied in the plane of bending.
7. The transverse section of the beam is symmetrical about a line passing through the centre of gravity in the plane of bending.
8. The radius of curvature of the beam before bending is very large in comparison to the transverse dimensions.

As a result of a bending moment or couple, a length of beam will take up a curved shape and a very short length may be treated as a part of the arc of circle. It follows that at the outer radii the material will be in tension and at the inner radii in compression and at some radius there will be no stress. This layer of the material is the neutral layer or neutral axis.

Fig 5.1 shows a longitudinal section of a beam, the neutral layer (axis) N.A. being bent to form an arc of a circle of radius R. The neutral layer is then, before bending, the length pq, which after bending becomes p'q'.

Consider some layer rs at a distance Y from pq which after bending becomes r's'. Let p'q' subtend an angle  $\alpha$  at the centre of curvature.

$$\therefore p'q' = R \alpha \text{ and } r's' = (R - y) \alpha$$

Initially the parallel layers would have equal lengths, so that  $Pq = rs$  and since there is no stress at the neutral layer, then there is no strain.

$$\therefore p'q' = pq$$

$$\text{Now the strain in } rs = \frac{rs - r's'}{rs} \text{ but } rs = pq = p'q'$$

$$\therefore \text{Strain} = \frac{p'q' - r's'}{rs}$$

$$\text{But } p'q' = R \alpha \text{ and } r's' = (R - Y) \alpha$$

$$\text{Strain} = \frac{R \alpha - (R - Y) \alpha}{R \alpha} = \frac{Y}{R}$$

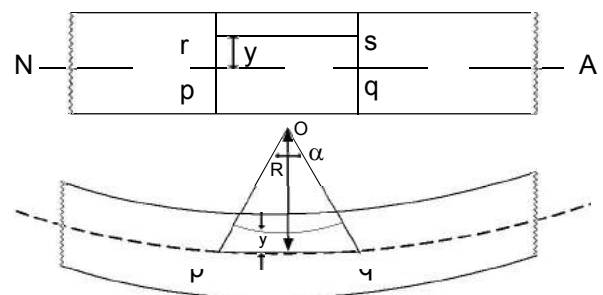

Fig. 5.1

Now if the stress in rs =  $\sigma$  & young's modulus = E

$$\text{then strain } \frac{\sigma}{E} = \frac{Y}{R} \text{ or } \frac{\sigma}{Y} = \frac{E}{R} \dots (5.1)$$

If a transverse section of the beam is now considered (Fig. 5.2) let a strip of area  $\delta a$ , lie at a distance Y from the neutral axis.

$$\text{Then, the normal force on this area } (\delta a) = \frac{E}{R} y \delta a$$

$$\text{Now the moment of this force about the neutral axis is } = \frac{E}{R} y \delta a x y \text{ or } \frac{E}{R} y^2 \delta a$$

This is the resisting moment of the material caused by the stress produced and the total resisting moment is  $= \sum \frac{E}{R} y^2 \delta a$  or  $\frac{E}{R} \sum y^2 \delta a$

And  $= \sum y^2 \delta a$  B the second moment of area about the neutral axis,  $I_{NA}$ .

$$\therefore \text{Resisting moment } M = \frac{E}{R} \times I$$

But since the resisting moment balances the applied bending moment,

$$\therefore M \frac{E}{R} \times I \text{ or } \frac{M}{I} = \frac{E}{R}$$

$$\text{But } \frac{E}{R} = \frac{\sigma}{Y} \therefore \frac{M}{I} = \frac{\sigma}{Y} = \frac{E}{R} \dots (5.2)$$

Where,

M = moment of resistance

I = Moment of inertia of the section about neutral axis (N.A.)

E = Yong's modulus of elasticity

R = Radius of Curvature of N.A

$\sigma$  = Bending stress

The above equation is known as the 'Bending equation'.

### Position of Neutral Axis

Consider the cross-section of a beam (Fig. 5.2), there will be no resultant force on the section for condition of equilibrium.

The force acting on a small area  $\delta a$  at a distance 'y' from the neutral axis is given by

$$SF = \sigma \cdot \delta a = \frac{E}{R} Y \cdot \delta a$$

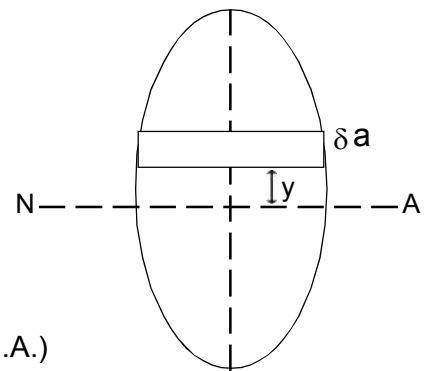

Fig. 5.2

Or the total force normal to the section,

$$F = \frac{E}{R} \sum Y \cdot \delta a$$

$\therefore$  For zero resultant force,  $\sum Y \cdot \delta a = 0$

Now  $\sum Y \cdot \delta a$  is the moment of the sectional area about the neutral axis and since this moment is zero, the axis must pass through the centre of area.

Hence the neutral axis or neutral layer, passes through the centre of area.

### Section Modulus

Referring to the bending equation,  $\frac{M}{I} = \frac{\sigma}{Y}$ ,  $\sigma = \frac{MY}{I}$

$$\text{or } \sigma = \frac{M}{Z} \text{ where } Z = \text{section modulus} = \frac{I}{Y}$$

The section modulus is usually quoted for all standard sections and practically is of greater use. The strength of the beam section depends mainly on the section modulus.

The section moduli of rectangular and circular sections are calculated below.

#### (i) Rectangular section

Fig. 5.3 shows a rectangular section of width  $b$  & depth  $d$ .

Let the horizontal centroidal axis be neutral axis.

Section modulus  $Z = \frac{\text{Moment of inertia about the neutral axis}}{\text{Distance of the most distant point of the section from the neutral axis.}}$

$$= \frac{I}{Y_{\max}}$$

But  $I = \frac{bd^3}{12}$  and  $Y_{\max} = \frac{d}{2}$

$$\therefore Z = \frac{\frac{bd^3}{12}}{\frac{d}{2}} = \frac{bd^2}{6}$$

$$\text{Moment of resistance, } M = \sigma Z = \sigma \times \frac{1}{6} bd^2 \dots (5.4)$$

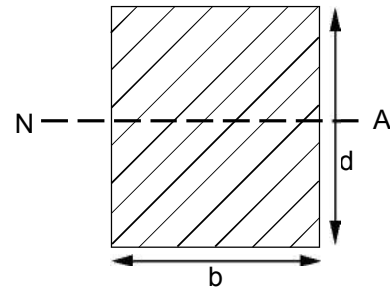

Fig. 5.3

#### (ii) Hollow rectangular section

Refer to Fig. 5.4.

Moment of inertia of the section about the neutral axis.

$$I = \frac{BD^3}{12} - \frac{bd^3}{12} = \frac{1}{12} (BD^3 - bd^3), Y_{\max} = \frac{D}{2}$$

$$\therefore \text{Section modulus } = Z = \frac{I}{Y_{\max}}$$

$$= \frac{(BD^3 - bd^3) / 12}{D/2} = \left[ \frac{BD^3 - bd^3}{6D} \right]$$

$$\text{Moment of resistance, } M = \sigma Z = \sigma \times \left[ \frac{BD^3 - bd^3}{6D} \right]$$

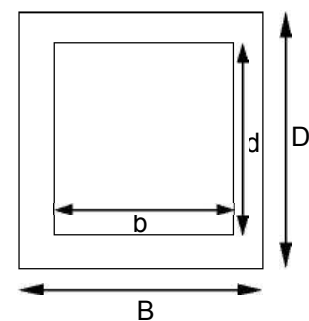

Fig. 5.4



**(iii) Circular section**

Refer to Fig 5.5

Moment of inertia of the section about the neutral axis.

$$I = \frac{\pi d^4}{64}, Y_{\max} = \frac{d}{2}$$

$$\begin{aligned} \therefore \text{Section modulus} = Z &= \frac{I}{Y_{\max}} \\ &= \frac{\pi d^4 / 64}{d/2} = \frac{\pi d^3}{32} \dots (5.6) \end{aligned}$$

$$\text{Moment of resistance, } M = \sigma Z = \sigma \times \frac{\pi d^3}{32}$$

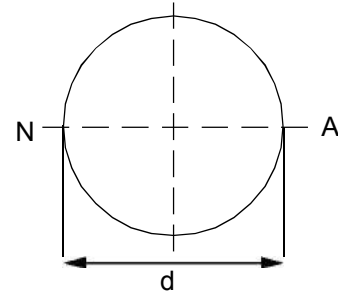

**Fig. 5.5**

**(iv) Hollow circular section**

Refer to Fig 5.6

Moment of inertia of the section about the neutral axis.

$$I = \frac{\pi}{64} (D^4 - d^4), Y_{\max} = \frac{D}{2}$$

$$\begin{aligned} \therefore \text{Section modulus} = Z &= \frac{I}{Y_{\max}} \\ &= \frac{\pi (D^4 - d^4)}{64} \times \frac{2}{D} = \frac{\pi}{32} \left[ \frac{(D^4 - d^4)}{D} \right] \dots (5.7) \end{aligned}$$

$$\text{Moment of resistance, } M = \sigma Z = \sigma \times \frac{\pi (D^4 - d^4)}{32 D}$$

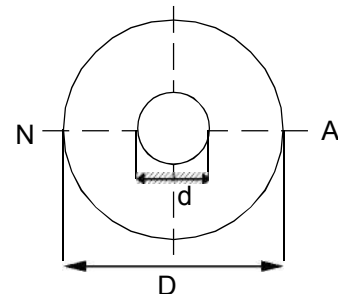

**Fig. 5.6**

**Example**

A 250mm (depth) x 150mm (width) rectangular beam is subjected to maximum bending moment of 750 KNm determine.

- (i) The maximum stress in the beam.
- (ii) If the value of E for the beam material is 200 GN/m<sup>2</sup>.

Find out the radius of curvature for that portion of the beam where the bending is maximum.

- (iii) The value of the longitudinal stress at a distance of 65mm from the top surface of the beam.

Solution : Refer to Fig 5.7

Width of the beam = b = 150 mm = 0.15m

Depth of the beam = d = 250 mm = 0.25m

Maximum bending moment M = 750KN.m

Young's modulus of elasticity, E = 200 GN/m<sup>2</sup>....

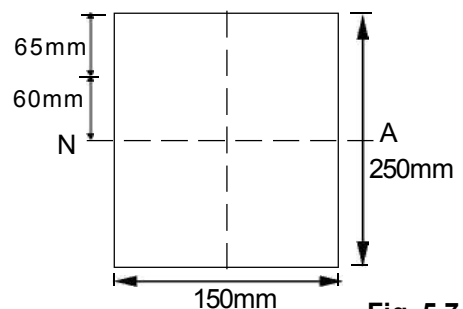

**Fig. 5.7**

(i) Maximum stress in the beam :

$$\text{Moment of inertia } I = \frac{bd^4}{12} = \frac{0.15 \times 0.25^4}{12} = 0.0001953 \text{m}^4$$

Distance of the neutral axis (N.A) from top surface of the beam

$$Y = \frac{d}{2} = \frac{0.25}{2} = 0.125 \text{m}$$

$$\text{using the relation } \frac{M}{I} = \frac{\sigma}{Y},$$

$$\begin{aligned} \text{we get } \sigma &= \frac{M \cdot Y}{I} = \frac{750 \times 10^3 \times 0.125}{0.0001953} \\ &= 4.8 \times 10^8 \text{ N/mm}^2 = 480 \text{ MN/m}^2 \end{aligned}$$

Hence the maximum stress in the beam = 480 MN/m<sup>2</sup> (Ans)

(ii) Radius of curvature, R:

$$\text{Using the relation } \frac{M}{I} = \frac{E}{R}, R = \frac{EI}{M} = \frac{200 \times 10^9 \times 0.0001953}{750 \times 10^3} = 52.08 \text{m (Ans)}$$

(iii) Longitudinal stress at a distance of 65mm from top surface of the beam, using the

$$\text{relation } \frac{M}{I} = \frac{\sigma}{Y} = \frac{\sigma_1}{Y_1}$$

$$\begin{aligned} \text{we get } \sigma_1 &= \frac{M Y_1}{I} = \frac{750 \times 10^3 \times (60 \times 10^{-3})}{0.0001953} \times 10^{-6} = \text{MN/m}^2 \\ &= 230.4 \text{ MN/m}^2 \text{ (Ans)} \end{aligned}$$

## CHAPTER 6.0

# STRUT

A structural member subjected to an axial compressive force is called a strut.

Column

It is a vertical strut used in building or frame.

Axial load on column

The column fails by compressive stress.

The load, the least value of  $P$  which will cause the column to buckle, and it is called the Euler or crippling load.

The column in actual practice is subjected to following end conditions.

- (1) Both ends hinged
- (2) Both ends fixed
- (3) One end is fixed and other end hinged.
- (4) One end is fixed and other end free.

### 6.2 Eccentric load in columns

#### Eccentric load

A load whose line of action does not coincide with the axis of a column is called eccentric load.

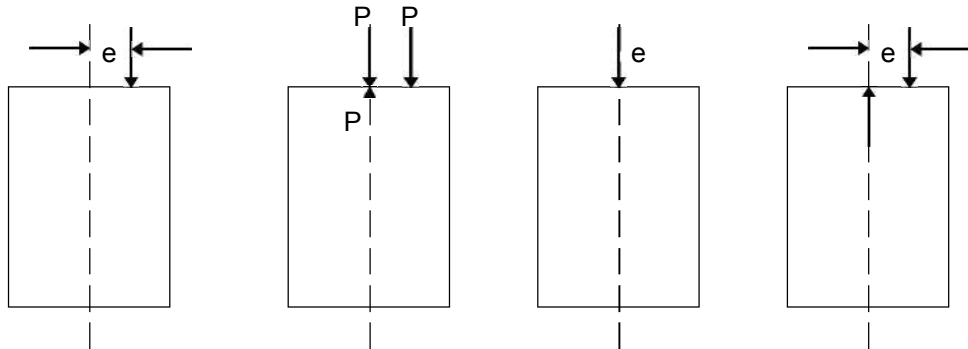

Direct stresses, bending stresses, maximum & minimum stresses.

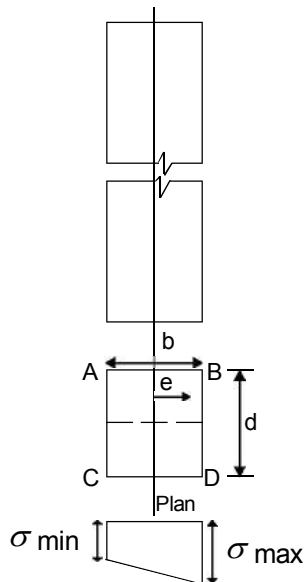

Let  $P$  = Load acting on the column

$e$  = Eccentricity of the load

$b$  = Width of the column section

$d$  = Thickness of the column

Now Area of the section =  $bd$

$$\text{Moment of Inertia, } I = \frac{d \cdot b^3}{12}$$

$$\text{Modulus of section, } Z = \frac{I}{y} = \frac{\frac{d \cdot b^3}{12}}{\frac{b}{12}} = \frac{db^2}{12}$$

$$\text{Direct stress, } \sigma_0 = \frac{P}{A}$$

Moment due to load,  $M = p \cdot e$

Bending stress at any point of column section at a distance  $y$  from  $y$ - $y$ -axis

$$\sigma_b = \frac{M}{I} y = \frac{M}{Z}$$

or

$$\text{at } y = \frac{b}{2}$$

$$\sigma_b = \frac{M \cdot \frac{b}{2}}{\frac{db^3}{12}} = \frac{6M}{db^3} = \frac{6p \cdot e}{db^2} = \frac{6p \cdot e}{A \cdot b}$$

Total stress = direct stress + bending stress

$$= \frac{P}{A} \pm \frac{M}{Z} = \frac{P}{A} \pm \frac{6P \cdot e}{Ab}$$

### Problem

A rectangular column 200mm wide and 150mm thick is carrying a vertical load of 120kN at an eccentricity of 50mm in a plane bisecting the thickness determine the maximum and minimum intensities of stress in the section.

### Solution

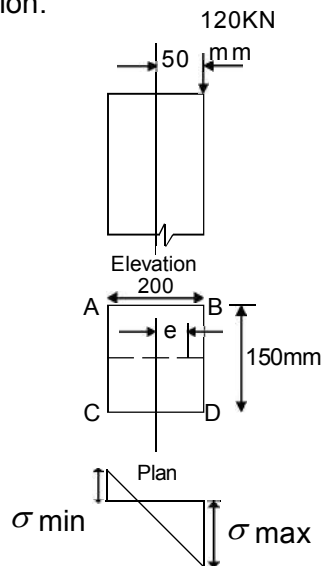

### **Given**

$$b = 200 \text{ mm, } d = 150 \text{ mm, } p = 120 \text{ kN, } e = 50 \text{ mm}$$

Maximum stress

$$A = b \times d = 200 \times 150 = 30,000 \text{ mm}^2$$

$$\begin{aligned} \sigma_{\max} &= \frac{P}{A} \left( 1 + \frac{6e}{b} \right) \\ &= \frac{120 \times 10^3}{30,000} \left( 1 + \frac{6 \times 50}{200} \right) \\ &= 10 \text{ N/mm}^2 = 10 \text{ MPa (Ans)} \end{aligned}$$

**Minimum Stress**

$$\begin{aligned} \sigma_{\min} &= \frac{P}{A} \left( 1 - \frac{6e}{b} \right) \\ &= \frac{120 \times 10^3}{30,000} \left( 1 - \frac{6 \times 50}{200} \right) \\ &= -2 \text{ MPa (tension)} \end{aligned}$$

**6.4 Buckling load computation**

(1) Columns with both ends hinged

$$P = \frac{\pi^2 EI}{L^2}$$



(2) Columns with one end fixed and the other free

$$P = \frac{\pi^2 EI}{4L^2}$$

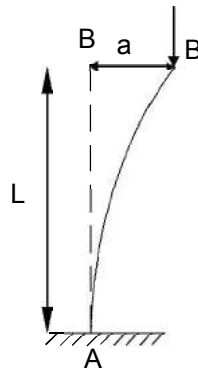

**Coehers**

E – Youngs modulus

I = Moment of Inertia about YY-axis.

(3) Columns with both ends fixed.

$$P = \frac{\pi^2 EI}{L^2}$$

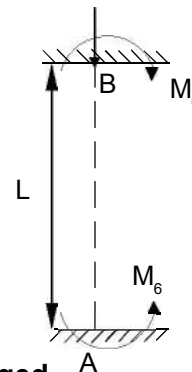

(4) Columns with one end fixed and the other hinged.

$$P = \frac{\pi^2 EI}{L^2}$$

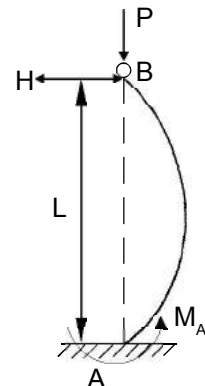

## TORSION

### 7.1 Assumption of pure torsion

If a shaft is acted upon by a pure torque  $T$  about its polar axis, shear stress will be set up in directions perpendicular to the radius on all transverse sections. This is called as the shaft under torsion.

Following assumptions are made.

1. The material of the shaft is uniform through out
2. The twist along the shaft is uniform.
3. Normal cross sections of the shaft, which were plane and circular before the twist, remains plane and circular even after the twist.
4. All diameters of the normal cross section which were straight before the twist, remain straights with their magnitude unchanged, after the twist.

### 7.2 The torsion equation for solid shaft.

These above assumption is justified by the symmetry of the section.

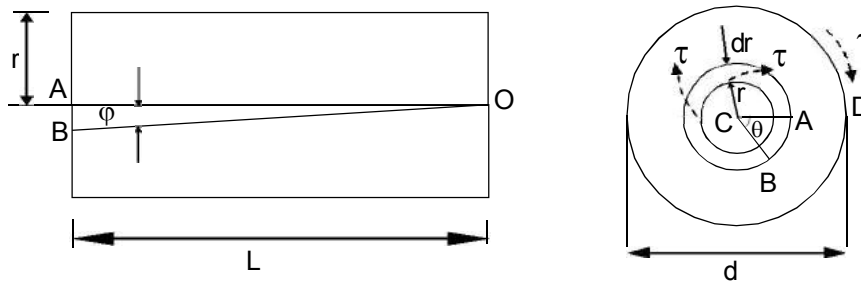

The left hand figure shows the shear strain  $\phi$  of elements at a distance  $r$  from the axis ( $\phi$  is constant for constant  $T$ ), so that a line originally  $OA$  twists to  $OB$ , and  $\angle ACB = \theta$  the relative angle of twist of cross sections a distance  $L$  apart.

$$\text{Arc } AB = r\theta = L\phi \text{ (approx)}$$

$$\text{But } \phi = \frac{\tau}{G}, \text{ where } G \text{ - modulus of rigidity}$$

$$\text{or } \phi = \frac{r \cdot \theta}{L}$$

$$\frac{r \cdot \theta}{L} = \frac{\tau}{G}$$

$$\text{or } \frac{\tau}{r} = \frac{G \cdot \theta}{L}$$

The torque can be equated to the sum of the moments of the tangential stresses on the element  $2\pi r dr$ ;

$$\text{i.e. } T = \int \tau(2\pi r dr)r$$

$$\text{or, } T = \frac{G\theta}{L} \cdot J$$

Where J polar moment of inertial

$$\frac{T}{J} = \frac{G\theta}{L}$$

$$\text{combing } \frac{T}{J} = \frac{\tau}{r} = \frac{G\theta}{L}$$

$$\text{for a solid shaft } J = \frac{\pi D^4}{32}$$

and the max stress

$$\tau_{\max} = \frac{16T}{\pi D^3} \text{ at } r = \frac{D}{2}$$

for a hollow shaft

$$J = \frac{\pi}{32}(D^4 - d^4)$$

$$\text{and } \tau_{\max} = \frac{16 \cdot D \cdot T}{\pi(D^4 - d^4)} \text{ at } r = \frac{D}{2}$$

$$\text{Torsional stiffness, } K = \frac{T}{\theta} = \frac{GJ}{L}$$

### 7.3 Comparison between solid and hollow shaft subjected to pure torsion.

Example

Compare the weights of equal lengths of hollow and solid shaft to transmit a given torque for the same maximum shear stress if the inside diameter is  $\frac{2}{3}$  of the outside.

**Solution**

$$\text{Nro, } \frac{T}{\tau} = \frac{2J}{D} = \frac{\pi D^3}{16} \text{ for solid shaft}$$

$$\text{and } \frac{T}{\tau} = \frac{\pi(D_1^4 - d^4)}{16D} \text{ for hollow shaft}$$

$$\text{or } \frac{T}{\tau} = \frac{\pi D_1^3}{16} \left( 1 - \left( \frac{2}{3} \right)^4 \right)$$

$$= \frac{65 \times \pi D_1^3}{81 \times 16}$$

Equating these two shaft

$$\frac{\pi D^3}{16} = \frac{65 \times \pi D_1^3}{81 \times 16}$$

$$D_1 = D \cdot 3 \sqrt[3]{81/65} = 1.075D$$

$$D_1 = 1.075D$$

Ratio of weights of equal lengths

$$\begin{aligned} &= (D_1^2 - d^2) / D^2 \\ &= (D_1/d)^2 \left(1 - \frac{4}{9}\right) \\ &= \left(\frac{5}{9}\right)^2 \times 1.075^2 \\ &= 0.642 \end{aligned}$$

### **Problem**

A circular shaft of 50mm diameter is required to transmit torque from one shaft to another find the safe torque, which the shaft can transmit. If the  $\tau = 40\text{MPa}$

### **Solution**

$$D = 50\text{mm}, \tau_{\max} = 40\text{MPa}$$

we know

$$\begin{aligned} T &= \frac{\pi}{16} \times \tau D^3 \\ &= \frac{\pi}{16} \times 40 \times 50^3 \\ &= 0.982 \times 10^6 \text{ N} - \text{mm} \\ &= 0.982 \text{ KN} - \text{m} \end{aligned}$$